



Кондиционеры Mitsubishi Heavy

Техническое руководство

Кондиционеры настенного типа SRK20HB, SRK28HB, SRK40HB



CONTENTS

| | |
|---|-----------|
| 1 GENERAL INFORMATION | 1 |
| 1.1 Specific features | 1 |
| 1.2 How to read the model name | 1 |
| 2 SELECTION DATA | 2 |
| 2.1 Specifications | 2 |
| 2.2 Range of usage & limitations | 5 |
| 2.3 Exterior dimensions | 5 |
| 2.4 Piping system | 7 |
| 2.5 Selection chart | 9 |
| 3 ELECTRICAL DATA | 10 |
| 3.1 Electrical wiring | 10 |
| 4 FUNCTIONS | 13 |
| 4.1 Table of functions | 13 |
| 4.2 Details of functions | 14 |
| 5 APPLICATION DATA | 24 |
| 5.1 Selection of location for installation | 25 |
| 5.2 Installation of indoor unit | 26 |
| 5.3 Installation of outdoor unit | 28 |
| 5.4 Refrigerant piping | 29 |
| 5.5 Test run | 30 |
| 5.6 Precautions for wireless remote controller installation and operation | 31 |
| 6 MAINTENANCE DATA | 32 |
| 6.1 Trouble shooting | 32 |
| 6.2 Servicing | 37 |
| 6.3 Power supply remote operation | 38 |

1 GENERAL INFORMATION

1.1 Specific features

The “Mitsubishi Daiya” room air-conditioner: **SRK series** are of split and wall mounted type and the unit consists of indoor unit and outdoor unit with refrigerant precharged in factory. The indoor unit is composed of room air cooling or heating equipment with operation control switch and the outdoor unit is composed of condensing unit with compressor.

(1) Remote control flap

The flap can be automatically controlled by operating wireless remote control.

- AUTO : Flap operation is automatically control.
- Swing : This will swing the flap up and down.
- Memory flap : Once the flap position is set, the unit memorizes the position and continues to operate at the same position from the next time.

(2) Automatic operation

When the remote control switch is set on “auto”, it will either automatically decide operation mode such as cooling, heating and thermal dry, or operate in the operation mode before it has been turned to automatic control.

(3) Self diagnosis function

We are constantly trying to do better service to our customers by installing such judges that show abnormality of operation as follows.

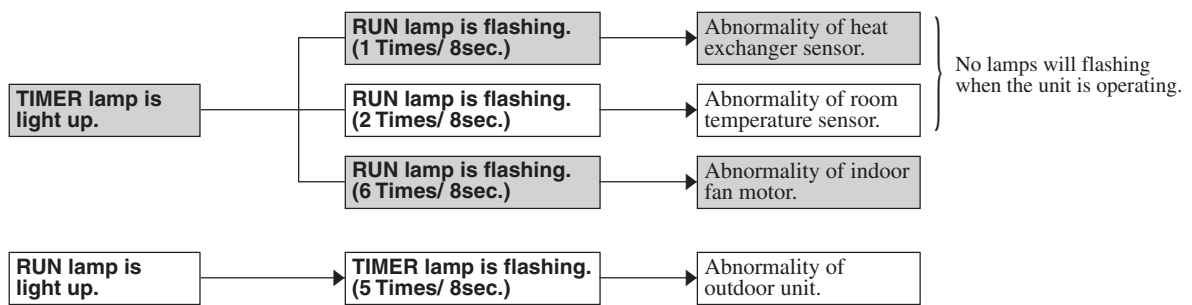

1.2 How to read the model name

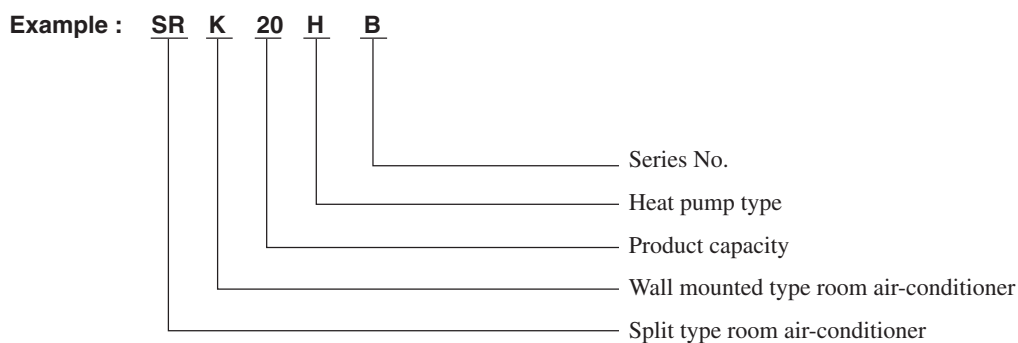

2 SELECTION DATA

2.1 Specifications

Model SRK20HB (Indoor unit)
SRC20HB (Outdoor unit)

| Item | | Model | SRK20HB | SRC20HB |
|---------------------------------|----------------------------|--------|--|--|
| Cooling capacity ⁽¹⁾ | | W | 1800/1850 | |
| Heating capacity ⁽¹⁾ | | W | 2000/2050 | |
| Power source | | | 1 Phase, 220/240V, 50Hz | |
| Operation data ⁽¹⁾ | Cooling input | kW | 0.690/0.775 | |
| | Running current (Cooling) | A | 3.4/3.6 | |
| | Heating input | kW | 0.620/0.735 | |
| | Running current (Heating) | A | 3.0/3.4 | |
| | Inrush current | A | 17.3/18.9 | |
| | COP (In cooling) | | 2.61/2.39 | |
| | Noise level ⁽⁵⁾ | dB(A) | Cooling: 36/37 Heating: 38/39 | Cooling: 46/47 Heating: 47/48 |
| Exterior dimensions | | | | |
| Height x Width x Depth | | mm | 275 x 790 x 174 | 492 x 750 x 220 |
| Color | | | Noble white | Polar white |
| Net weight | | kg | 7.5 | 27 |
| Refrigerant equipment | | | | |
| Compressor type & Q'ty | | | - | RM5485GNE2 (Rotary type) x 1 |
| Motor | | kW | - | 0.65 |
| Starting method | | | - | Line starting |
| Heat exchanger | | | Louver fins & bare tubing | |
| Refrigerant control | | | Capillary tubes | |
| Refrigerant ⁽⁴⁾ | | kg | R22 0.62 | |
| Refrigerant oil | | ℓ | 0.35 (BARREL FREEZE 32SAM) | |
| Defrost control | | | MC control | |
| Air handling equipment | | | | |
| Fan type & Q'ty | | | Tangential fan x 1 | Propeller fan x 1 |
| Motor | | W | 16 | 17 |
| Air flow (at High) | (Cooling) | CMM | 7.0 | 21/22 |
| | (Heating) | | 7.5 | 21/22 |
| Air filter, Q'ty | | | Polypropylene net (washable) x 2 | - |
| Shock & vibration absorber | | | - | Cushion rubber (for compressor) |
| Electric heater | | | - | - |
| Operation control | | | | |
| Operation switch | | | Wireless-Remote controller | - |
| Room temperature control | | | MC. Thermostat | - |
| Pilot lamp | | | RUN (Green), TIMER (Yellow) | - |
| Safety equipment | | | - | Dome mounted protector (for compressor) Internal thermostat (for fan motor) |
| Refrigerant piping | O.D | mm(in) | Liquid line: ø6.35 (1/4") Gas line: ø9.52 (3/8") | |
| | Connecting method | | Flare connecting | |
| | Attached length of piping | | Liquid line: 0.44m Gas line : 0.39m | - |
| | Insulation | | Necessary (Both sides) | |
| Drain hose | | | Connectable | |
| Power source cord | | | 2.5m (3 cores with Earth) | |
| Connection wiring | Size x Core number | | 1.5mm ² x 5 cores (Including earth cable) | |
| | Connecting method | | Terminal block (Screw fixing type) | |
| Accessories (included) | | | Mounting kit | |
| Optional parts | | | - | |

Notes (1) The data are measured at the following conditions.

| Item | Indoor air temperature | | Outdoor air temperature | | Standards |
|---------|------------------------|------|-------------------------|------|-------------------|
| | DB | WB | DB | WB | |
| Cooling | 27°C | 19°C | 35°C | 24°C | JIS C9612, ISO-T1 |
| Heating | 20°C | - | 7°C | 6°C | JIS C9612, ISO-T1 |

(2) The operation data are applied to the 220V or 240V districts respectively

(3) Limitation of Voltage application

Minimum: 198V Maximum: 264V

(4) The refrigerant quantity to be charged includes the refrigerant in 7.5m connecting piping.

(Purging is not required even in the short piping.)

If the piping length is longer, when it is 10 m, add 20g refrigerant per meter and when it is 10 to 15m, add 30g refrigerant per meter.

(5) Expressed in sound pressure level.

Model SRK28HB (Indoor unit)
SRC28HB (Outdoor unit)

| Item | | Model | SRK28HB | SRC28HB |
|---------------------------------|----------------------------|--------|--|--|
| Cooling capacity ⁽¹⁾ | | W | 2500/2500 | |
| Heating capacity ⁽¹⁾ | | W | 2900/3000 | |
| Power source | | | 1 Phase, 220/240V, 50Hz | |
| Operation data ⁽¹⁾ | Cooling input | kW | 0.930/1.005 | |
| | Running current (Cooling) | A | 4.5/4.6 | |
| | Heating input | kW | 0.83/0.91 | |
| | Running current (Heating) | A | 4.0/4.1 | |
| | Inrush current | A | 18.2/19.6 | |
| | COP (In cooling) | | 2.69/2.49 | |
| | Noise level ⁽⁵⁾ | dB(A) | Cooling: 38/39 Heating: 38/41 | Cooling: 41/42 Heating: 42/43 |
| Exterior dimensions | | | | |
| Height x Width x Depth | | mm | 275 x 790 x 174 | 542 x 795 x 255 |
| Color | | | Noble white | Polar white |
| Net weight | | kg | 7.5 | 33 |
| Refrigerant equipment | | | | |
| Compressor type & Q'ty | | | - | RM5512GNE1 (Rotary type) x 1 |
| Motor | | kW | - | 0.75 |
| Starting method | | | - | Line starting |
| Heat exchanger | | | Louver fins & inner grooved tubing | |
| Refrigerant control | | | Capillary tubes | |
| Refrigerant ⁽⁴⁾ | | kg | R22 0.88 | |
| Refrigerant oil | | ℓ | 0.35 (SUNISO Z300HDS) | |
| Defrost control | | | MC control | |
| Air handling equipment | | | | |
| Fan type & Q'ty | | | Tangential fan x 1 | Propeller fan x 1 |
| Motor | | W | 16 | 11 |
| Air flow (at High) | (Cooling) | CMM | 7.5 | 23 |
| | (Heating) | | 8.0 | 23 |
| Air filter, Q'ty | | | Polypropylene net (washable) x 2 | - |
| Shock & vibration absorber | | | - | Cushion rubber (for compressor) |
| Electric heater | | | - | - |
| Operation control | | | | |
| Operation switch | | | Wireless-Remote controller | - |
| Room temperature control | | | MC. Thermostat | - |
| Pilot lamp | | | RUN (Green), TIMER (Yellow) | - |
| Safety equipment | | | - | Dome mounted protector (for compressor) Internal thermostat (for fan motor) |
| Refrigerant piping | O.D | mm(in) | Liquid line: ø6.35 (1/4") Gas line: ø9.52 (3/8") | |
| | Connecting method | | Flare connecting | |
| | Attached length of piping | | Liquid line: 0.44m Gas line : 0.39m | - |
| | Insulation | | Necessary (Both sides) | |
| Drain hose | | | Connectable | |
| Power source cord | | | 2.5m (3 cores with Earth) | |
| Connection wiring | Size x Core number | | 1.5mm ² x 5 cores (Including earth cable) | |
| | Connecting method | | Terminal block (Screw fixing type) | |
| Accessories (included) | | | Mounting kit | |
| Optional parts | | | - | |

Notes (1) The data are measured at the following conditions.

| Item | Indoor air temperature | | Outdoor air temperature | | Standards |
|-----------|------------------------|------|-------------------------|------|-------------------|
| | DB | WB | DB | WB | |
| Operation | | | | | |
| Cooling | 27°C | 19°C | 35°C | 24°C | JIS C9612, ISO-T1 |
| Heating | 20°C | - | 7°C | 6°C | JIS C9612, ISO-T1 |

(2) The operation data are applied to the 220V or 240V districts respectively

(3) Limitation of Voltage application

Minimum: 198V Maximum: 264V

(4) The refrigerant quantity to be charged includes the refrigerant in 7.5m connecting piping.

(Purging is not required even in the short piping.)

If the piping length is longer, when it is 10 m, add 20g refrigerant per meter and when it is 10 to 15m, add 30g refrigerant per meter.

(5) Expressed in sound pressure level.

Model SRK40HB (Indoor unit)
SRC40HB (Outdoor unit)

| Item | | Model | SRK40HB | SRC40HB |
|---------------------------------|----------------------------|--------|--|--|
| Cooling capacity ⁽¹⁾ | | W | 3500/3500 | |
| Heating capacity ⁽¹⁾ | | W | 4100/4100 | |
| Power source | | | 1 Phase, 220/240V, 50Hz | |
| Operation data ⁽¹⁾ | Cooling input | kW | 1.320/1.405 | |
| | Running current (Cooling) | A | 6.4/6.4 | |
| | Heating input | kW | 1.335/1.460 | |
| | Running current (Heating) | A | 6.5/6.5 | |
| | Inrush current | A | 33.6/36.6 | |
| | COP (In cooling) | | 2.65/2.49 | |
| | Noise level ⁽⁵⁾ | dB(A) | Cooling: 40/42 Heating: 41/43 | Cooling: 47/49 Heating: 48/50 |
| Exterior dimensions | | mm | 275 x 790 x 174 | 542 x 795 x 255 |
| Height x Width x Depth | | | | |
| Color | | | Noble white | Polar white |
| Net weight | | kg | 8 | 37 |
| Refrigerant equipment | | | | RH231V (Rotary type) x 1 |
| Compressor type & Q'ty | | | - | |
| Motor | | kW | - | 1.3 |
| Starting method | | | - | Line starting |
| Heat exchanger | | | Louver fins & bare tubing | |
| Refrigerant control | | | Capillary tubes | |
| Refrigerant ⁽⁴⁾ | | kg | R22 1.3 | |
| Refrigerant oil | | ℓ | 0.6 (BARREL FREEZE 32SAM) | |
| Defrost control | | | MC control | |
| Air handling equipment | | | | |
| Fan type & Q'ty | | | Tangential fan x 1 | Propeller fan x 1 |
| Motor | | W | 16 | 18 |
| Air flow (at High) | (Cooling) | CMM | 8.5/8.5 | 22/22.5 |
| | (Heating) | | 9.5/9.5 | 22/22.5 |
| Air filter, Q'ty | | | Polypropylene net (washable) x 2 | - |
| Shock & vibration absorber | | | - | Cushion rubber (for compressor) |
| Electric heater | | | - | - |
| Operation control | | | | |
| Operation switch | | | Wireless-Remote controller | - |
| Room temperature control | | | MC. Thermostat | - |
| Pilot lamp | | | RUN (Green), TIMER (Yellow) | - |
| Safety equipment | | | - | Dome mounted protector (for compressor) Internal thermostat (for fan motor) |
| Refrigerant piping | O.D | mm(in) | Liquid line: ø6.35 (1/4") Gas line: ø12.7 (1/2") | |
| | Connecting method | | Flare connecting | |
| | Attached length of piping | | Liquid line: 0.44m Gas line : 0.39m | - |
| | Insulation | | Necessary (Both sides) | |
| Drain hose | | | Connectable | |
| Power source cord | | | 2.5m (3 cores with Earth) | |
| Connection wiring | Size x Core number | | 1.5mm ² x 5 cores (Including earth cable) | |
| | Connecting method | | Terminal block (Screw fixing type) | |
| Accessories (included) | | | Mounting kit | |
| Optional parts | | | - | |

Notes (1) The data are measured at the following conditions.

| Item | Indoor air temperature | | Outdoor air temperature | | Standards |
|---------|------------------------|------|-------------------------|------|-------------------|
| | DB | WB | DB | WB | |
| Cooling | 27°C | 19°C | 35°C | 24°C | JIS C9612, ISO-T1 |
| Heating | 20°C | - | 7°C | 6°C | JIS C9612, ISO-T1 |

(2) The operation data are applied to the 220V or 240V districts respectively

(3) Limitation of Voltage application

Minimum: 198V Maximum: 264V

(4) The refrigerant quantity to be charged includes the refrigerant in 7.5m connecting piping.

(Purging is not required even in the short piping.)

If the piping length is longer, when it is 10 m, add 20g refrigerant per meter and when it is 10 to 15m, add 30g refrigerant per meter.

(5) Expressed in sound pressure level.

(2) Outdoor unit
Model SRC20HB

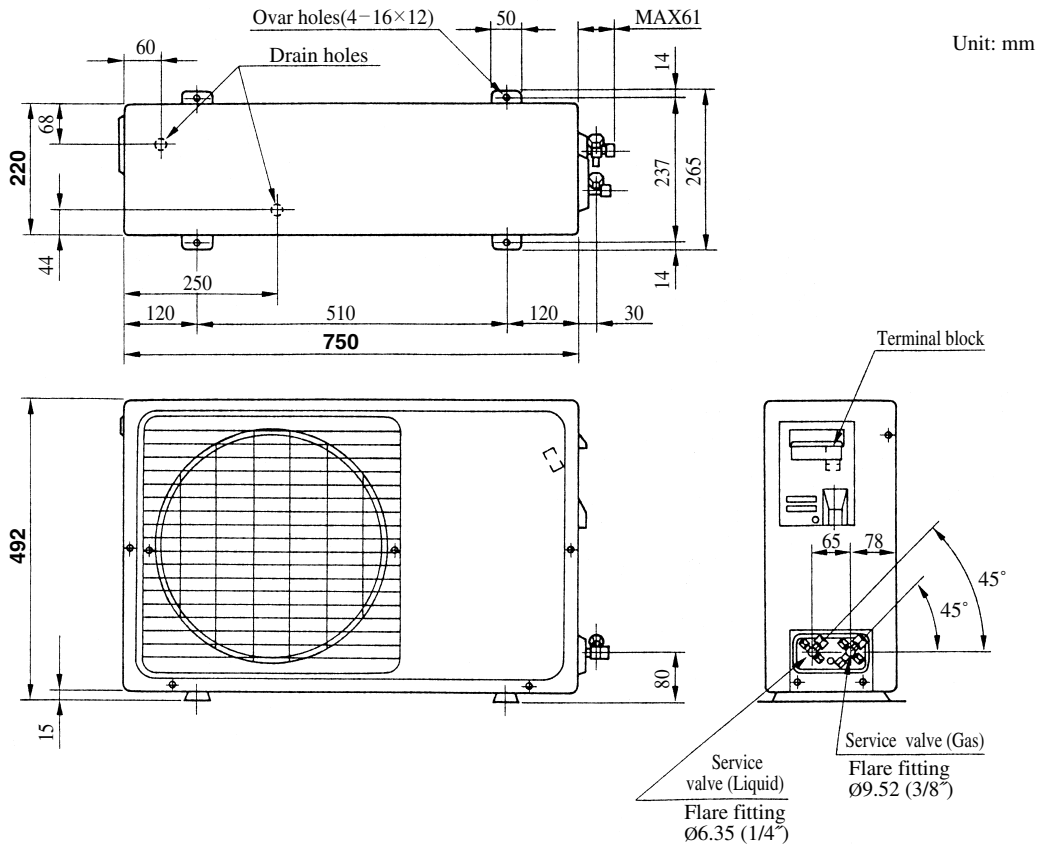

Models SRC28HB, 40HB

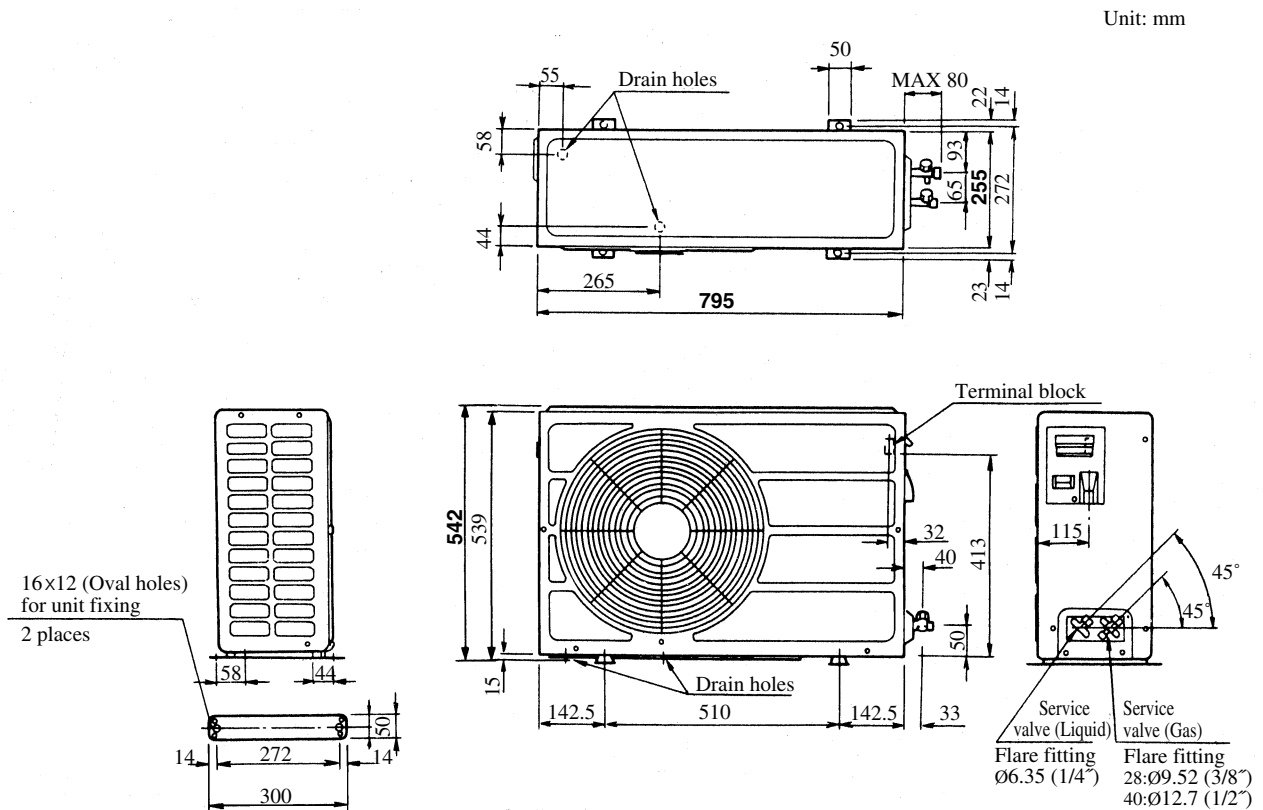

2.4 Piping system

Model SRK20HB

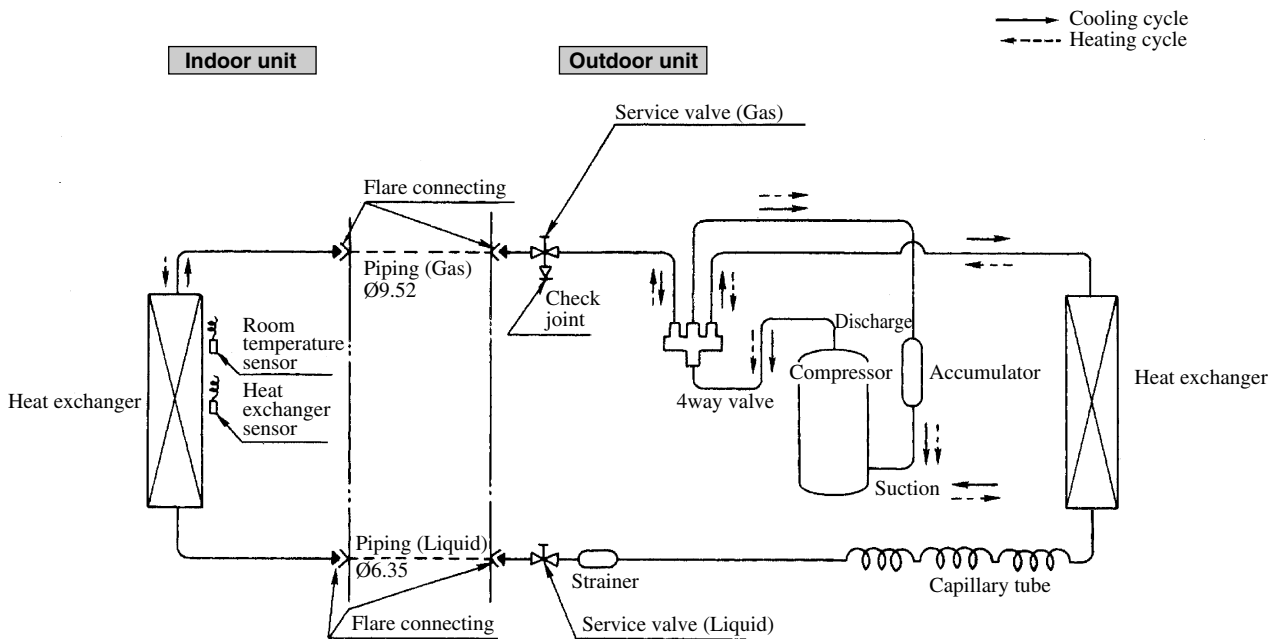

Model SRK28HB

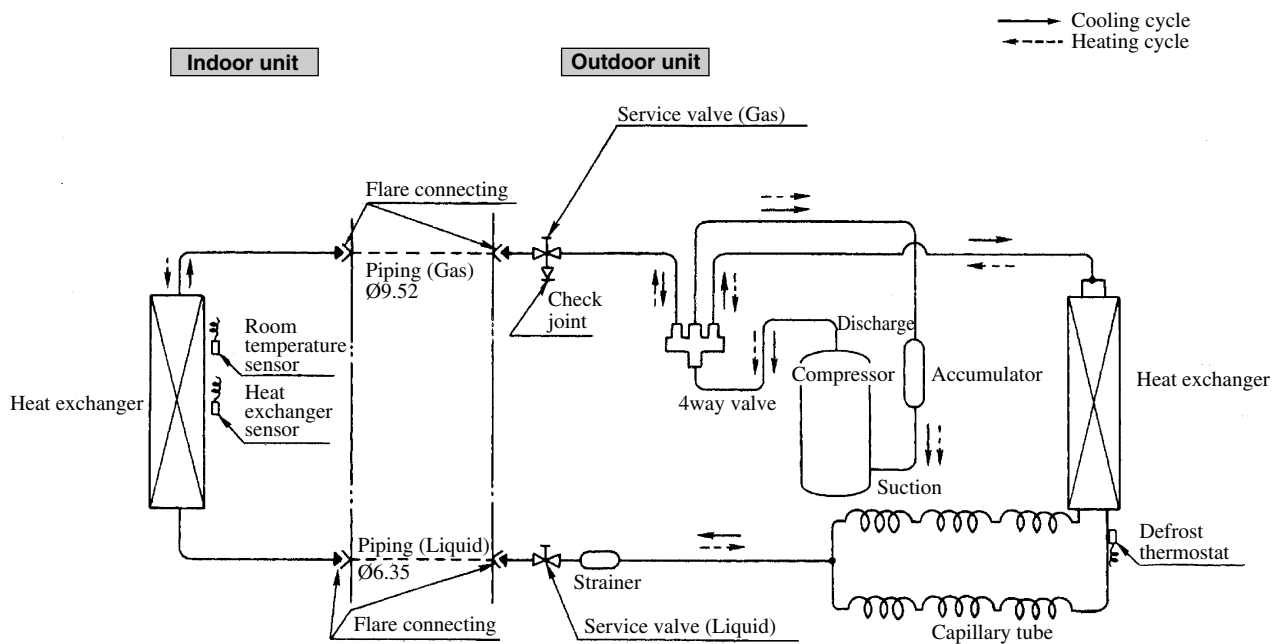

Model SRK40HB

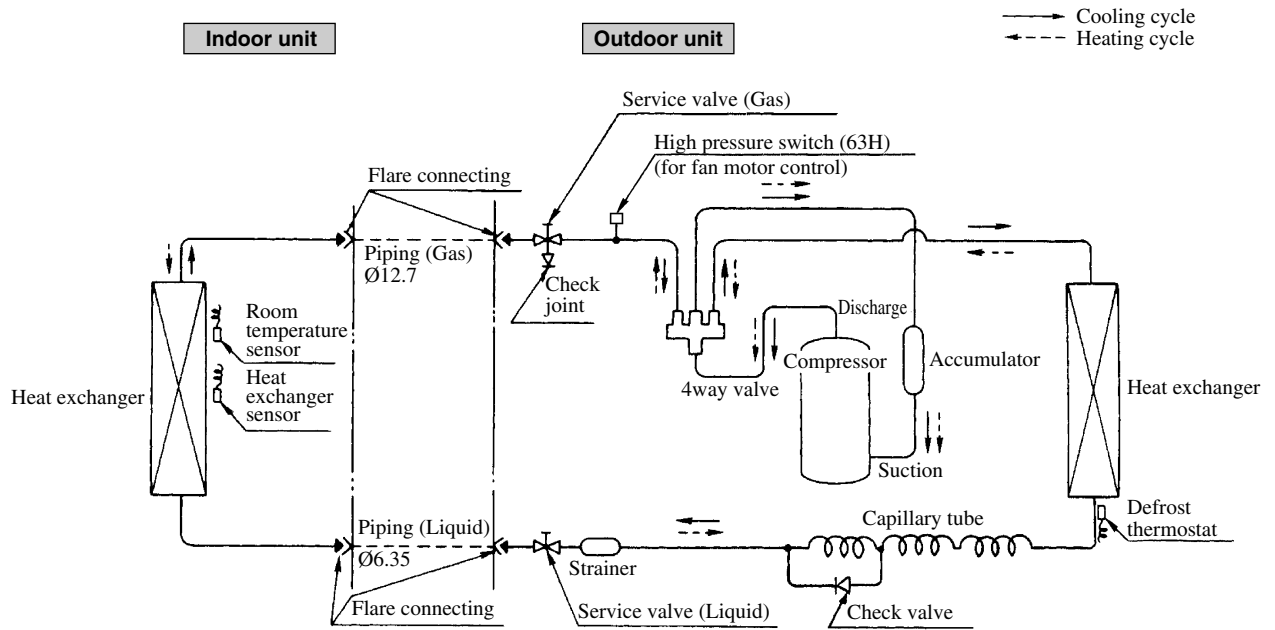

2.5 Selection chart

Correct the cooling and heating capacity in accordance with the conditions as follows. The net cooling and heating capacity can be obtained in the following way.

Net capacity = Capacity shown on specification × Correction factors as follows.

(1) Coefficient of cooling and heating capacity in relation to temperatures

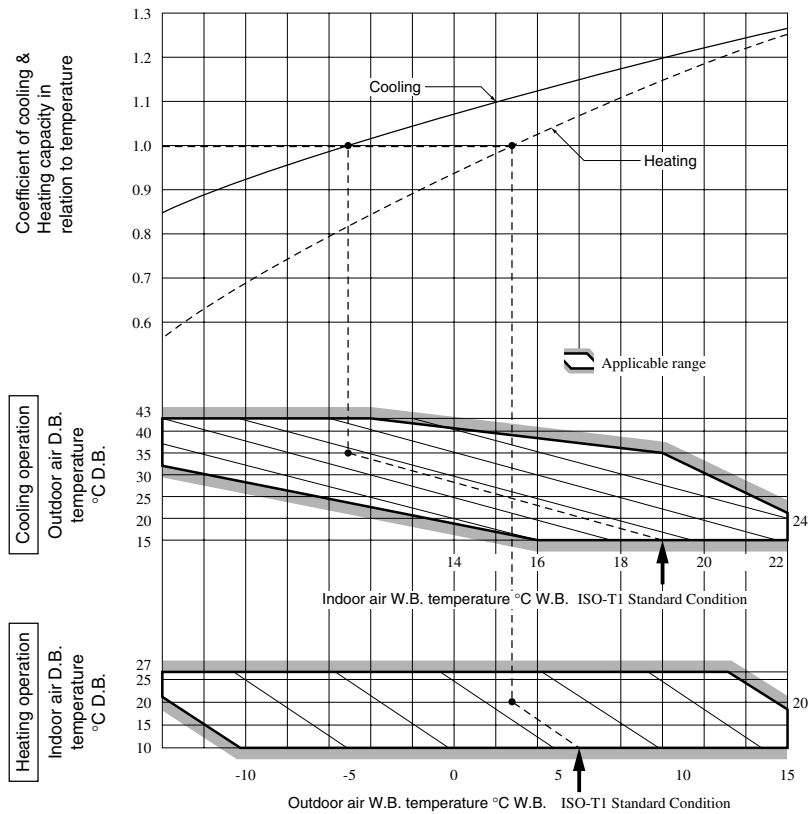

(2) Correction of cooling and heating capacity in relation to one way length of refrigerant piping

It is necessary to correct the cooling and heating capacity in relation to the one way piping length between the indoor and outdoor units.

| Piping length [m] | 7 | 10 | 15 |
|-------------------|-----|------|-------|
| Cooling | 1.0 | 0.99 | 0.975 |
| Heating | 1.0 | 1.0 | 1.0 |

(3) Correction relative to frosting on outdoor heat exchanger during heating

In additions to the foregoing corrections (1), (2) the heating capacity needs to be adjusted also with respect to the frosting on the outdoor heat exchanger.

| Air inlet temperature of outdoor unit in °CWB | -10 | -9 | -7 | -5 | -3 | -1 | 1 | 3 | 5 |
|---|------|------|------|------|------|------|------|------|------|
| Adjustment coefficient | 0.95 | 0.94 | 0.93 | 0.91 | 0.88 | 0.86 | 0.87 | 0.92 | 1.00 |

How to obtain the cooling and heating capacity

Example : The net cooling capacity of the model SRK28HB with the piping length of 15m, indoor wet-bulb temperature at 19.0°C and outdoor dry-bulb temperature 35°C is Net cooling capacity =

$$\begin{array}{ccccccc}
 \frac{2500}{\uparrow} & \times & \frac{0.975}{\uparrow} & \times & \frac{1.0}{\uparrow} & = & 2437 \text{ w} \\
 \text{SRK28HB} & & \text{Length 15m} & & \text{Factor by air} & & \\
 & & & & \text{temperatures} & &
 \end{array}$$

3 ELECTRICAL DATA

3.1 Electrical wiring

Model SRK20HB

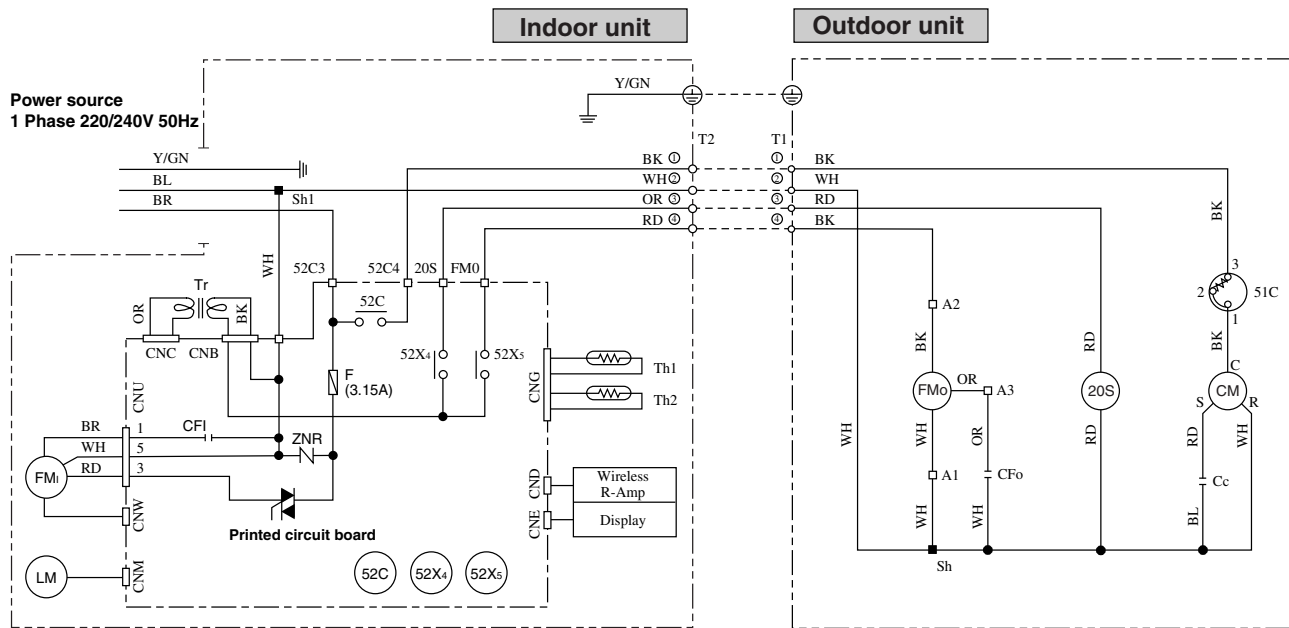

Color symbol

| | |
|------|--------------|
| BK | Black |
| BL | Blue |
| BR | Brown |
| RD | Red |
| OR | Orange |
| WH | White |
| Y/GN | Yellow/Green |

Meaning of marks

| Symbol | Parts name | Symbol | Parts name |
|--------|--------------------------|--------|---------------------------|
| Cc | Capacitor for CM | Th1,2 | Thermistor |
| CFi | Capacitor for FMi | Tr | Transformer |
| CFo | Capacitor for FMo | ZNR | Varistor |
| CM | Compressor motor | 20S | 4 way valve, coil |
| F | Fuse | 51C | Motor protector for CM |
| FMi | Fan motor (Indoor unit) | 52C | Magnetic contactor for CM |
| FMo | Fan motor (Outdoor unit) | 52X4,5 | Auxiliary relay |
| LM | Louver motor | | |

Table of relay operations

| Relay symbol | Operation Control part | Operation | | |
|--------------|------------------------|-----------|---------|---------|
| | | Cooling | Heating | Defrost |
| 52X4 | 20S | × | ○ | × |
| 52X5 | FMo | ○ | ○ | × |
| 52C | CM | ○ | ○ | ○ |

Notes (1) ○; denotes magnetized relay ×: denotes demagnetized relay
 (2) Th1 is room temperature sensor. Th2 (the heat exchanger sensor) is the hot start, hot keep, and frost prevention sensor.
 (for details, refer to pages 18,19,22)

Model SRK28HB

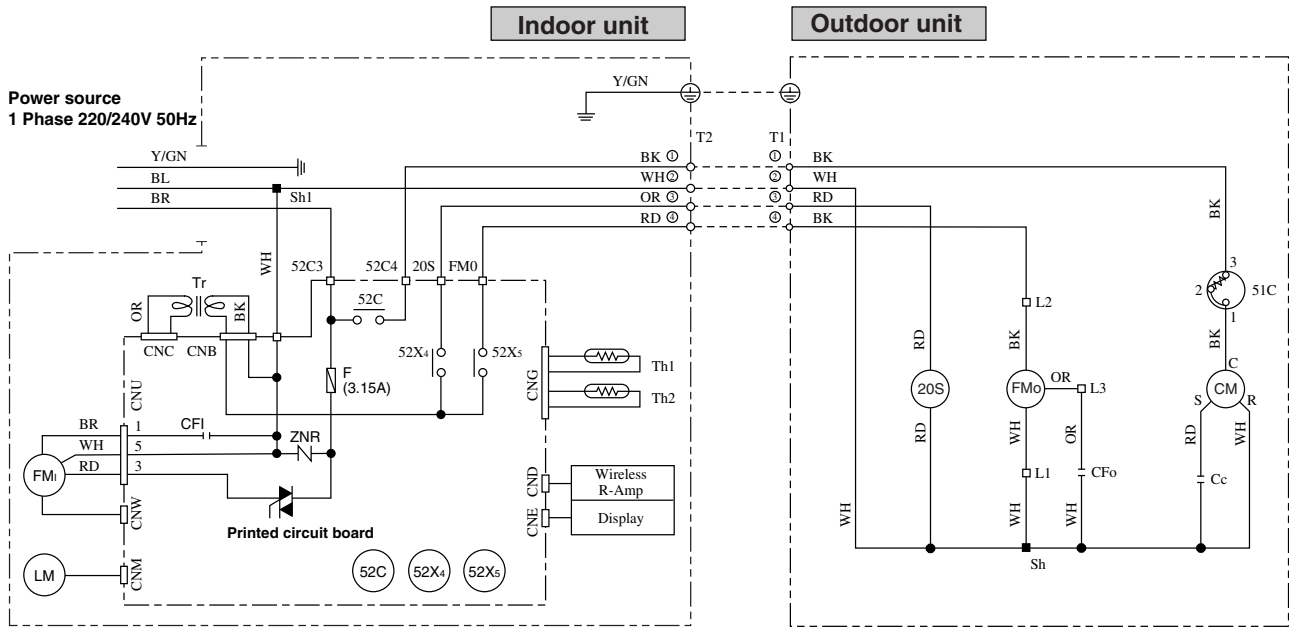

Color symbol

| | |
|------|--------------|
| BK | Black |
| BL | Blue |
| BR | Brown |
| RD | Red |
| OR | Orange |
| WH | White |
| Y/GN | Yellow/Green |

Meaning of marks

| Symbol | Parts name | Symbol | Parts name |
|--------|--------------------------|--------------------|---------------------------|
| Cc | Capacitor for CM | Th _{1,2} | Thermistor |
| CFi | Capacitor for FMi | Tr | Transformer |
| CFo | Capacitor for FMo | ZNR | Varistor |
| CM | Compressor motor | 20S | 4 way valve, coil |
| F | Fuse | 51C | Motor protector for CM |
| FMi | Fan motor (Indoor unit) | 52C | Magnetic contactor for CM |
| FMo | Fan motor (Outdoor unit) | 52X _{4,5} | Auxiliary relay |
| LM | Louver motor | | |

Table of relay operations

| Relay symbol | Operation Control part | Operation | | |
|------------------|------------------------|-----------|---------|---------|
| | | Cooling | Heating | Defrost |
| 52X ₄ | 20S | × | ○ | × |
| 52X ₅ | FMo | ○ | ○ | × |
| 52C | CM | ○ | ○ | ○ |

Notes (1) ○; denotes magnetized relay ×: denotes demagnetized relay
 (2) Th₁ is room temperature sensor. Th₂ (the heat exchanger sensor) is the hot start, hot keep, and frost prevention sensor.
 (for details, refer to pages 18,19,22)

Model SRK40HB

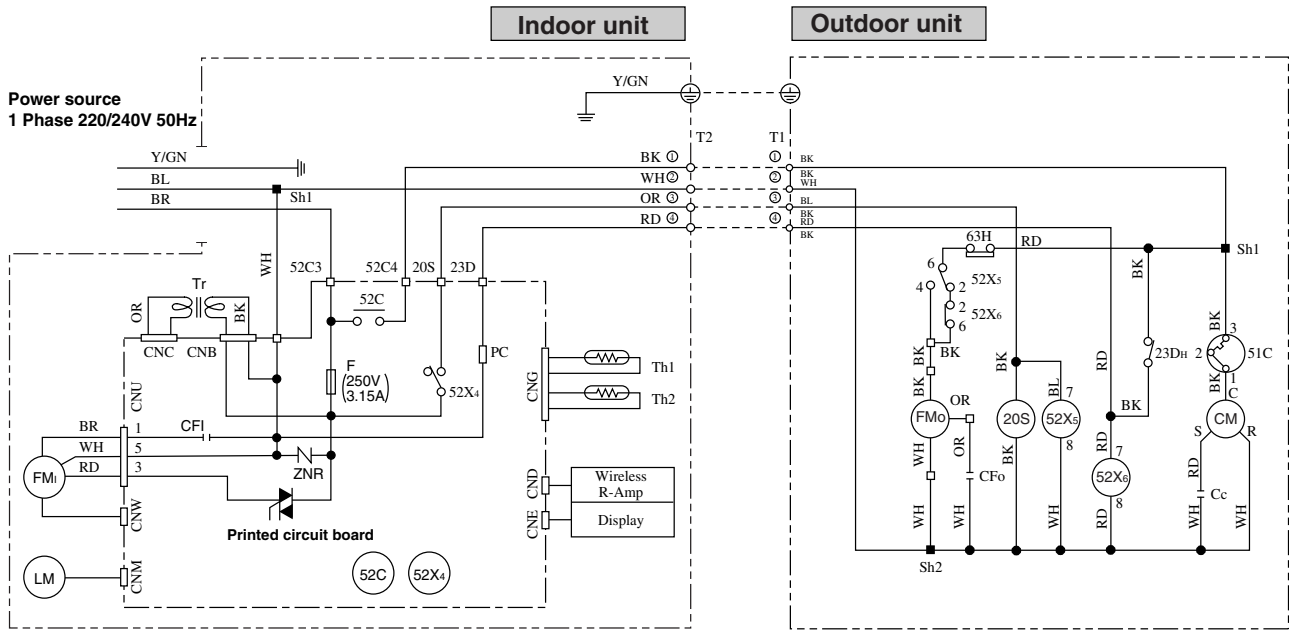

Color symbol

| | |
|------|--------------|
| BK | Black |
| BL | Blue |
| BR | Brown |
| RD | Red |
| OR | Orange |
| WH | White |
| Y/GN | Yellow/Green |

Meaning of marks

| Symbol | Parts name | Symbol | Parts name |
|--------|--------------------------|----------|---------------------------|
| Cc | Capacitor for CM | Th1,2 | Thermistor |
| CFi | Capacitor for FMi | Tr | Transformer |
| CFo | Capacitor for FMo | ZNR | Varistor |
| CM | Compressor motor | 20S | 4 way valve, coil |
| F | Fuse | 51C | Motor protector for CM |
| FMi | Fan motor (Indoor unit) | 52C | Magnetic contactor for CM |
| FMo | Fan motor (Outdoor unit) | 52X4,5,6 | Auxiliary relay |
| LM | Louver motor | 63H | High pressure switch |
| PC | Photo coupler | 23DH | Defrost thermostat |

Table of relay operations

| Relay symbol | Operation Control part | Operation | | |
|--------------|------------------------|-----------|---------|---------|
| | | Cooling | Heating | Defrost |
| 52X4 | 20S | × | ○ | × |
| 52X5 | FMo | × | ○ | × |
| 52X6 | | × | × | ○ |
| 52C | CM | ○ | ○ | ○ |

- Notes (1) ○: denotes magnetized relay ×: denotes demagnetized relay
 (2) Th1 is room temperature sensor. Th2 (the heat exchanger sensor) is the hot start, hot keep, and frost prevention sensor. (for details, refer to pages 18,19,22)
 (3) Preset values:
 23DH (defroster stop thermostat): opens at over 14°C
 63H (overload protection high pressure switch during heating): closes at 1.86 / opens at 2.41(MPa)

4 FUNCTIONS

4.1 Table for functions

| Functions | | Content | Referring page | | |
|---|---|--|--|--|----|
| Comfortability, Economical efficiency, Operational simplicity | High efficiency, low input rotary compressor | | Low input rotary compressor with high efficiency is equipped. | - | |
| | Wireless remote control | | All operation modes can be operated from distance place by the wireless remote control. And also liquid crystal is used to show all kinds to operation or, off, air flow switch, operation switch, timer switch, timer set, temperature set, flap control. | 16 | |
| | Micro computer control | Dry | Defumidifies while keeping room temperature to the thermostat setting level by M.C. thermostat. | 20 | |
| | | ON TIMER | ON timer setting for anytime during 12 hours can be performed. | 17 | |
| | | OFF TIMER | When OFF-TIMER operation is selected, the room temperature is automatically controlled after a while, ensuring that the room is not too cold during cooling or too warm during heating. <ul style="list-style-type: none"> • During COOL and DRY:the pre-set temperature is raised by 0.5°C at the start of OFF-TIMER operation (when the timer is set). After that, the temperature goes up by 0.5°C every 30 minutes to become 1.5°C higher within one hour. • During heating: Preset temperature is lowered by 1°C at the start of OFF-TIMER operation (when the timer is set). After that the temperature is lowered by 1°C every 30 minutes to become 3°C lower within one hour. | 17 | |
| | | Automatic fan control | Room unit air volume can be automatically controlled step by step, according to the difference between room temperature and setting temperature. <ol style="list-style-type: none"> 1. Shorten pull down time for cooling/heating operation 2. Low noise level operation can performed by proper air volume. | 18 | |
| | | 3 Hot system [Heat Pump type only] (in heating operation) | HOT START | When heating is initiated, thermostat reset, or heating resumed after defrosting , the indoor fan is automatically controlled stop to set valve in accordance with the temperature of the indoor air heat exchanger to prevent the blowing out of cold air. | 18 |
| | | | HOT SPURT | The thermostat temperature setting is automatically increased by 2°C when heating is initiated to provide faster stabilization of room temperature. | 19 |
| | | | HOT KEEP | The indoor fan is stopped depending on the temp, of the indoor heat exchanger to prevent the blowing-out of cold air when the heating operation is stopped by thermostat or defrosting operation is started. | 19 |
| | | Micro computer (MC) controlled timely defrosting operation (in heating) | | The change in the difference between the intake air temperature and the heat exchanger temperature causes the frost and condensation removal operation to start. | 21 |
| | | M. C. (Micro computer controlled) thermostat | | M. C thermostat improves on energy saving and comfort, by controlling room temperature with high accuracy. | - |
| | | Remote control flap | | The flap can be automatically controlled by operating wireless remote control. <ul style="list-style-type: none"> • AUTO : Flap operation is automatically controlled. • Swing : This will swing the flap up and down. • Memory flap : Once the flap position is set, the unit memorizes the position and continues to operate at the same position from the next time. | 14 |
| | Comfort timer (Cooling & Heating) | | The room temperature is checked 60 minutes before the timer is at ON. Depending on the temperature at that time, the operation starts 5 to 60 minutes before the timer is at ON. | 17 | |
| | Self diagnosis function | | We are constantly trying to do better service to our customers by installing such judges that show abnormality of each function as follows: <ul style="list-style-type: none"> • Abnormality of outdoor unit: <ul style="list-style-type: none"> TIMER lamp flashing. • Abnormality of indoor fan motor: <ul style="list-style-type: none"> RUN lamp flashing. • Abnormality of heat exchanger sensor: <ul style="list-style-type: none"> RUN lamp flashing. • Abnormality of room temperature sensor: <ul style="list-style-type: none"> RUN lamp flashing. <p style="margin-left: 150px;">} No lamp will flashing when the unit is operating</p> | 23 | |

4.2 Details of functions

(1) Flap control

Control the flap by the flap button on the wireless remote control

(a) AUTO(Natural flow)

The flap will be automatically set to the angle of air flow best to operation mode

(i) Starting time of operation

► In case of cooling and dry operation ◀

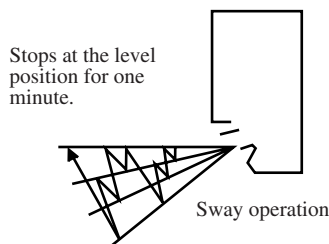

- The flap operation as shown above will be repeated.

► In case of heating operation ◀

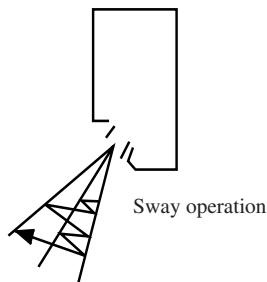

- When the room temperature controller (thermostat) is activated, horizontal blowing is applied to prevent cool wind from blowing out.

Air flow when flaps are used downward in heating

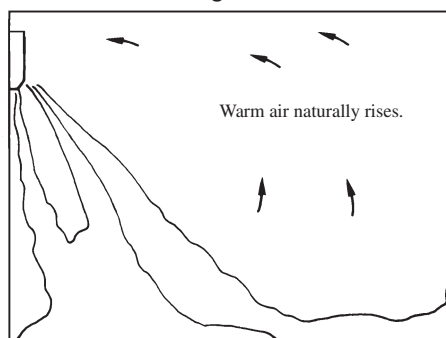

Warm air is sent to the floor, creating the ideal room temperature variation in which the feet are warmer and the air around the head slightly cooler.

(ii) When not operating

The flap returns to the position of air flow directly below, when operation has stopped.

(b) Memory flap

While the flap is operating if the AIRFLOW button is pushed once, it stops swinging at an angle.

As this angle is memorized in the microcomputer, the flap will be automatically set to the angle when next operation is started.

- Recommendable stopping angle of the flap

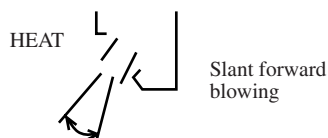
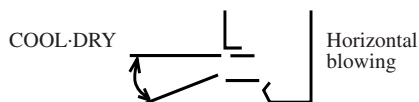

(c) Swing flap

Flap moves in upward and downward directions continuously.

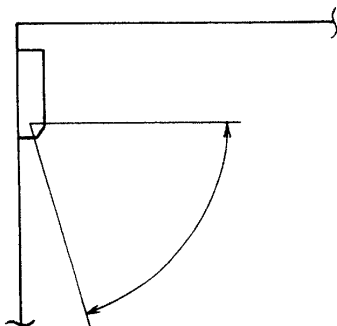

(2) Back-up Switch

When the remote controller batteries become weak, or if the remote controller is lost or malfunctioning, this switch may be used to turn the unit on and off.

(a) Operation

Push the switch once to place the unit in the automatic mode. Push it once more to turn the unit off.

(b) Details of operation

The unit will go into the automatic mode in which it automatically determines, from room temperature (as detected by sensor), whether to go into the cooling, thermal dry or heating modes.

| Function | Room temperature setting | Fan speed | Flap | Timer switch |
|----------------|--------------------------|-----------|------|--------------|
| Operation mode | | | | |
| Cooling | About 26°C | Auto | Auto | Continuous |
| Thermal dry | About 25°C | | | |
| Heating | About 25°C | | | |

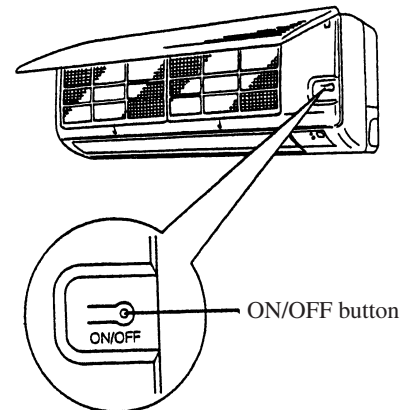

On operating in automatic operation mode by back-up switch, functions show in the above table are not altered, while, the other micro-computer control functions remain effective.

(3) AUTOMATIC operation

(a) When starting operation after more than 1 hour since operation stops

(Operation stop button ON or ON-Timer), this system operates indoor fan with Lo for 20 seconds checks room temperature and allowing decision of operating mode automatically.

| | Room temperature < 21°C | 21°C ≤ Room temperature < 26°C | 26°C ≤ Room temperature |
|----------------|-------------------------|--------------------------------|-------------------------|
| Operation Mode | Heating | Dry | Cooling |

Note (1) Operating Mode is not altered due to change of room temperature.

When intended to change operating mode, switch operation change over dial to the intended mode.

(b) Established temperature (operate by the established temperature button on remote controller).

| | | Wireless remote control signal (Indication) | | | | | | | | | | | | |
|---------------------|-------------|---|----|----|----|----|----|----|----|----|----|----|----|----|
| | | -6 | -5 | -4 | -3 | -2 | -1 | ±0 | +1 | +2 | +3 | +4 | +5 | +6 |
| Temperature setting | Cooling | 20 | 21 | 22 | 23 | 24 | 25 | 26 | 27 | 28 | 29 | 30 | 31 | 32 |
| | Thermal dry | 19 | 20 | 21 | 22 | 23 | 24 | 25 | 26 | 27 | 28 | 29 | 30 | 31 |
| | Heating | 19 | 20 | 21 | 22 | 23 | 24 | 25 | 26 | 27 | 28 | 29 | 30 | 31 |

(c) When switching to automatic operation during “Heating” “Cooling” “Dry” or when restarting with in 1 hour after stopping with automatic operation mode, the former operating mode is selected. (In this case, 20 seconds Lo operation of indoor fan is not performed). When the previous mode is in “FAN”, operation mode is to be set by the above mentioned chart.

(4) Operation control function by remote control switch

Remote control switch
◆ Operation section

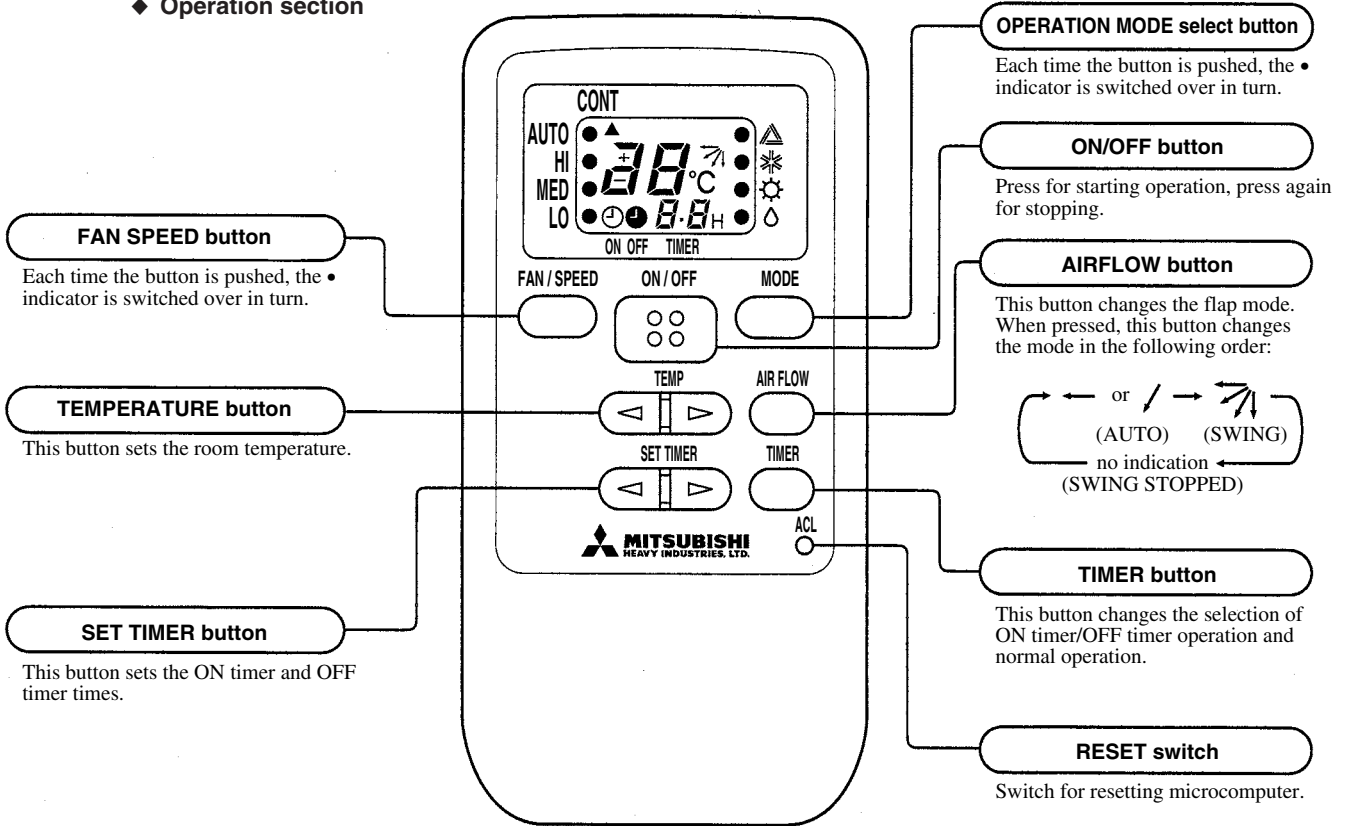

• The above illustration shows all controls, but in practice only the relevant parts are shown.

◆ Indication section

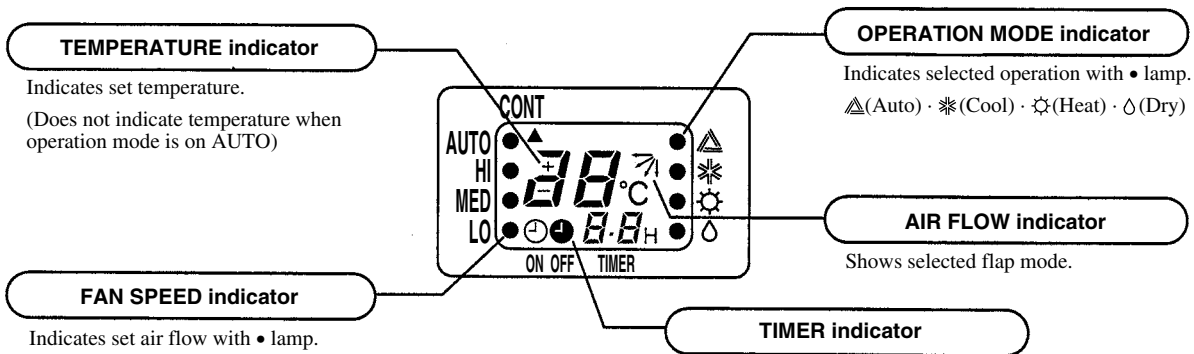

Unit indication section

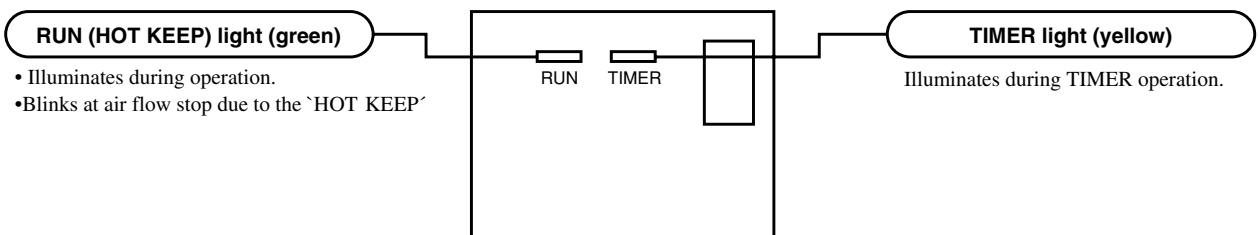

(a) Comfort timer

The room temperature is cracked 60 minutes before the timer is at ON.

Depending on the temperature at that time, the operation starts 5 to 60 minutes before the timer is at ON.

| Operation mode | Temperature sensor (Th1) | Operating start time (amount of time previous to set time that operation begins) |
|----------------|--------------------------|--|
| Heating | Under 5°C | 60 mins. |
| | Under 10°C | 30 mins. |
| | Under 15°C | 15 mins. |
| Cooling | Over 40°C | 60 mins. |
| | Over 35°C | 30 mins. |
| | Over 30°C | 15 mins. |

Note (1) Operation will start five minutes prior to the set time on the input timer regardless of temperature detected by the room temp. sensor.

(b) Timer time setting

The turn-off timer and turn-on timer can be set for up to 12 hours in units of 1 hour.

(c) Night time turn off

Placing the timer to this setting changes the temperature setting of the indoor set buttons as follows:

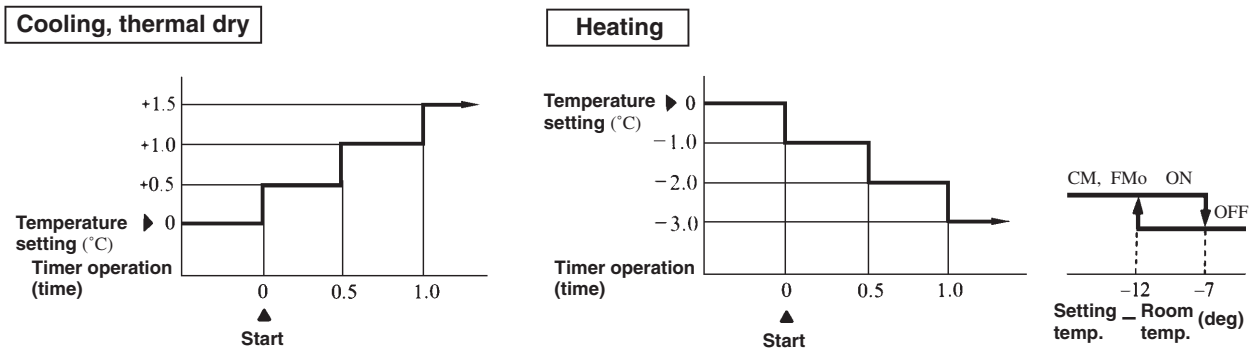

Note (1) The unit performs heating to the set time after 2.0 hours in the night timer as shown right.

(2) The unit performs low air volume operation to the set time after 2.0 hours in the night time.

(d) Temperature adjustment

- 1) Temperature adjustment setting may be set between 18 and 30°C.
- 2) The compressor and outdoor fan and turned on and off as shown below according to the temperature setting.

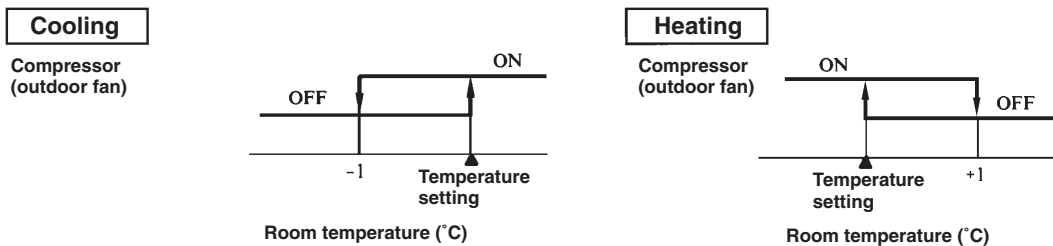

- 3) During the continuous mode, the compressor runs continuously in both cooling and heating. For thermal dry, please refer to page 20.

(e) Fan control

(i) Fan speed change

| Mode \ Fan speed knob | COOL | HEAT | FAN |
|-----------------------|-------------------|-------------------|-------------------|
| AUTO | See below | | |
| LOW | Speed 1 (Speed 1) | Speed 2 (Speed 2) | Speed 1 (Speed 1) |
| MED | Speed 2 (Speed 2) | Speed 3 (Speed 3) | Speed 2 (Speed 2) |
| HIGH | Speed 3 (Speed 4) | Speed 4 (Speed 5) | Speed 3 (Speed 3) |

Note (1) Please refer to page 20 regarding dry operation.
 (2) Fan speeds shown in brackets are shown for when continuing with set temperatures.

(ii) Fan speed knob: AUTO

The indoor fan is automatically controlled in accordance with the difference between the room temperature (detected by the room temperature sensor) and the thermostat setting as shown below.

| Mode \ Set-ting temp. | Heating | Cooling | Fan |
|-----------------------|---------|---------|---------|
| 18~30°C | | | |
| Continuous | Speed 5 | Speed 4 | Speed 3 |

Note (1) Please refer to page 20 regarding dry operation.

(5) 3 Hot system

When initiating heating operation, restoring thermostat, defrosting operation, the indoor fan motor and the thermostat is controlled by micro computer in accordance with the room air temp. and temp. of the indoor heat exchanger.

By this blowing of cold air is prevented and comfortable heating operation is assured.

Controls of thermostat and indoor fan motor.

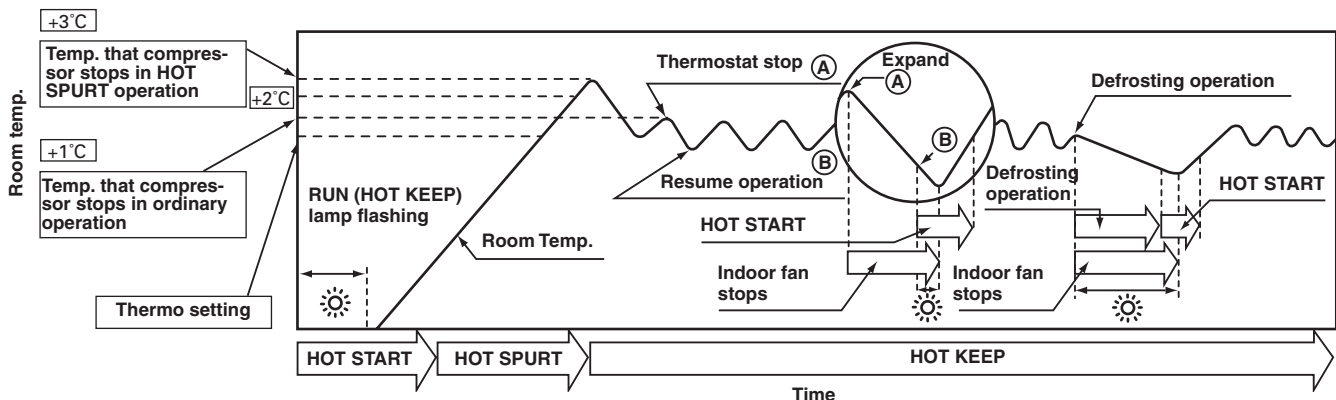

(a) HOT START (RUN (Hot keep) lamp flashing when the indoor fan is stopped)

(i) Operation timing

- ① When the compressor is starting. (when starting operation and resuming operation by restored thermostat)
- ② When the defrosting operation is switched to the heating operation.

(ii) Function

- ① The indoor fan motor is controlled in accordance with the temperature of the indoor heat exchanger to send warm air from the start.
- ② When the air flow increases at heating starting as shown below, the temperature of the indoor heat exchanger become lower since the intake air temperature is still low. By this the fan speed is decreased. In this case, in order to prevent excessively ON/OFF switching of the fan motor, the controlling temperature is made different from the controlling temperature for HOT KEEP.

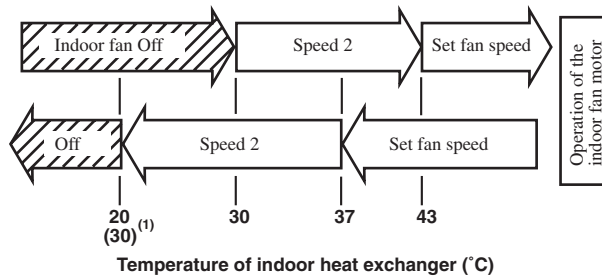

Note (1) When the compressor has stopped, the indoor fan will stop at 30°C

(b) HOT SPURT

(i) Operation timing

When starting operation. (during start-up)

(ii) Function

The set temperature of the thermostat is increased by 2°C to stabilize the room temperature quickly.

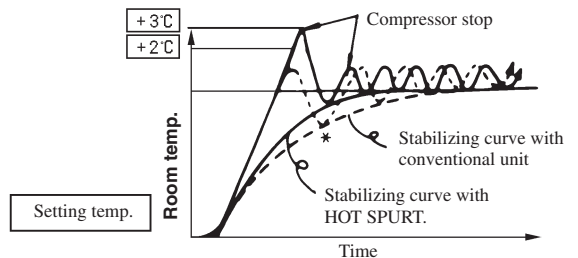

When starting heating, since the surrounding wall and furniture is

cold, if the compressor is stopped by thermostat, the 3 min. delay timer operates, the temperature drops rapidly during the 3 min. and although the thermostat has to resume operation, air conditioner would not start for those 3 min. (where marked *)

(c) HOT KEEP

1) Cold draft prevention (I)

- ① **Operation timing:** While defrosting operation
- ② **Function:** The indoor fan is stopped and RUN (HOT KEEP) lamp flashing.

2) Cold draft prevention (II)

- ① **Operation timing:** When thermostat is switched to "off".
- ② **Function:** The indoor fan operates as shown below, and after the passage of a period of either 5 minutes return to thermo. Control at speed 2 operation.

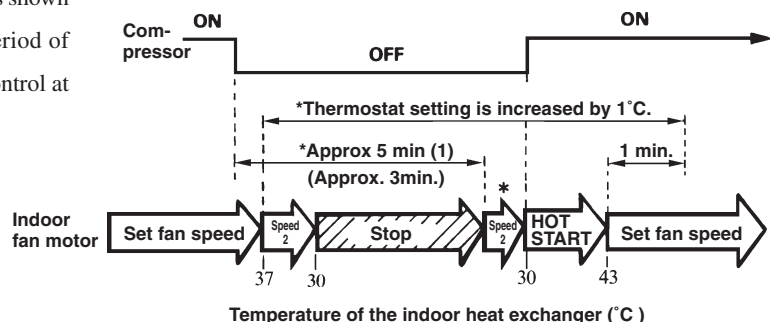

Notes (1) When the thermostat does not reset within 5 minutes, reset it by operating the indoor fan motor at speed 2.

(2) Refer to above explanation of HOT START function.

(3) The * marked speed 2 operation shows the case in which the thermostat is switched to off.

While the defrosting operation the * marked operation are not performed.

(6) DRY operation

(a) Choose the appropriate operation block area by the difference between room temperature and thermostat setting temperature as shown below.

- Operation block area

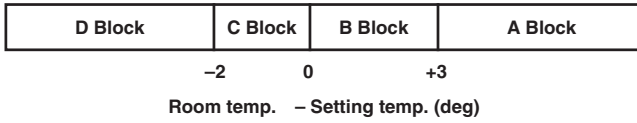

(b) Start up operation

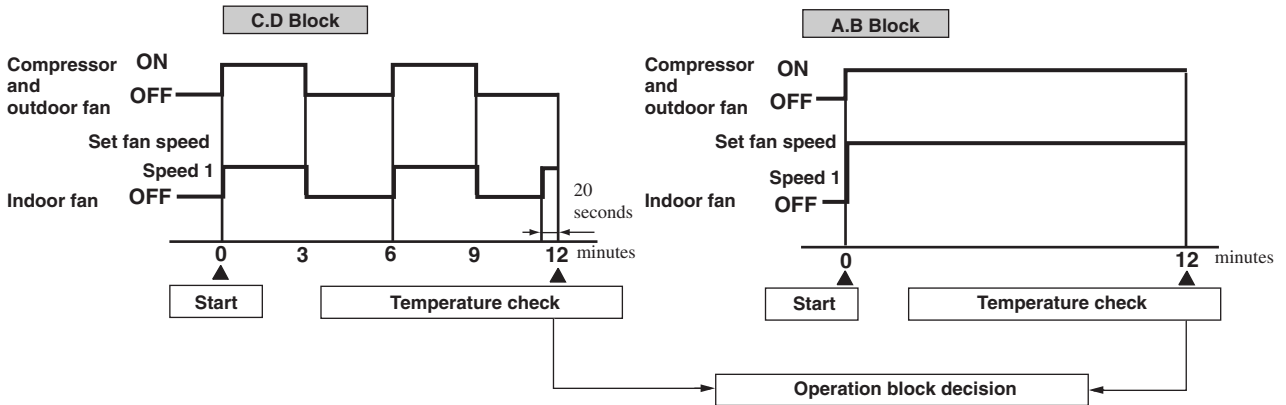

Notes (1) Thermostat operation is performed in A.B.Block. When compressor and indoor fan stop by thermostat operation within 12 minutes from start, temperature check is performed by operating indoor fan at speed 1 for 20 seconds before finishing 12 minutes and allowing decision of next operation block.

(c) DRY operation

After finishing start up operation described in (b) above, thermal dry operation is performed at 8 minutes intervals, according to the difference between room temperature and thermostat setting temperature as shown below.

Besides, 1 cycle of this operating time consists of 8 minutes, 7 cycle operation is performed then.

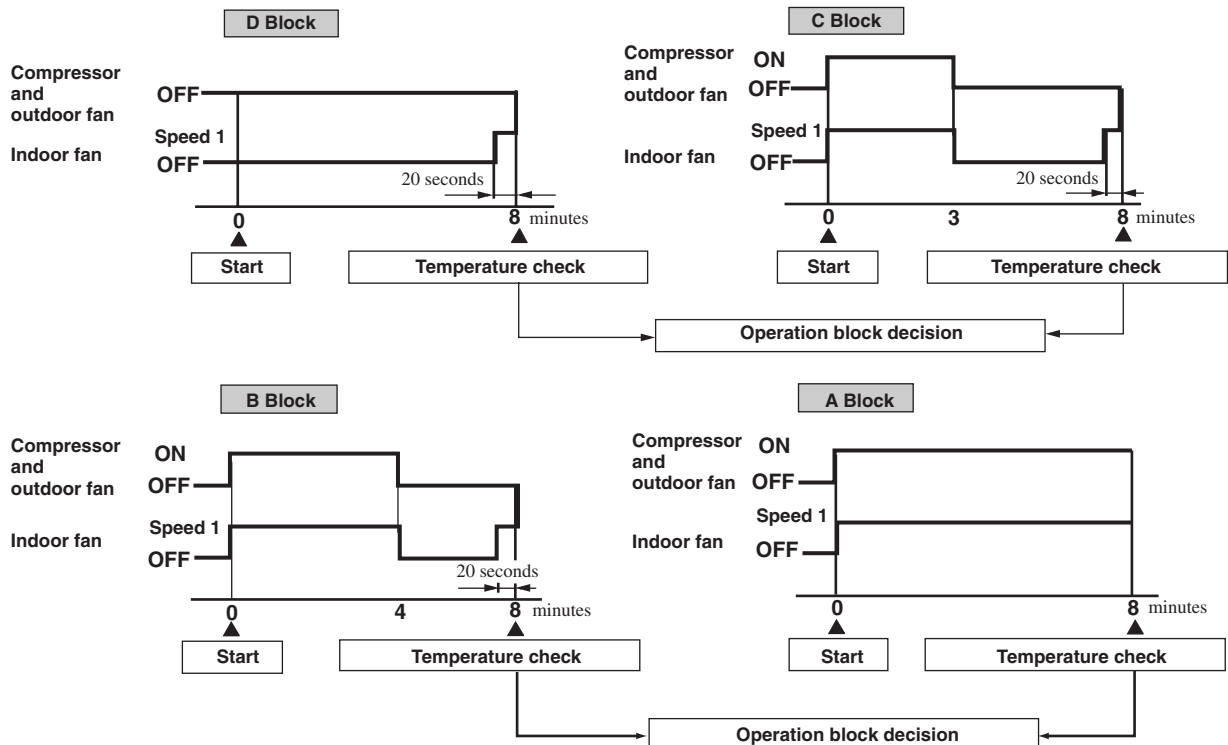

(7) Microcomputer Controlled Timely Defrosting Operation

(a) Defrost Start

Changes in the difference in temperature between the intake air temperature and the indoor heat exchanger temperature causes frost to build up, at which time defrosting begins. However, defrosting will not occur when the total compressor operation time or time after defrosting has ended is 40 minutes.

(b) Defrost End

◆ 20, 28 type

After defrosting has continued for 3 minutes or 7 minutes (when thermal is off before defrosting), defrosting will end and heating will begin again.

◆ 40 type

The operation ends and returns to heating operation when the outdoor heat exchanger temperature (detected at 23DH) reaches 14 °C or the defrosting operation time has exceeded 10 minutes.

Device operation during defrosting

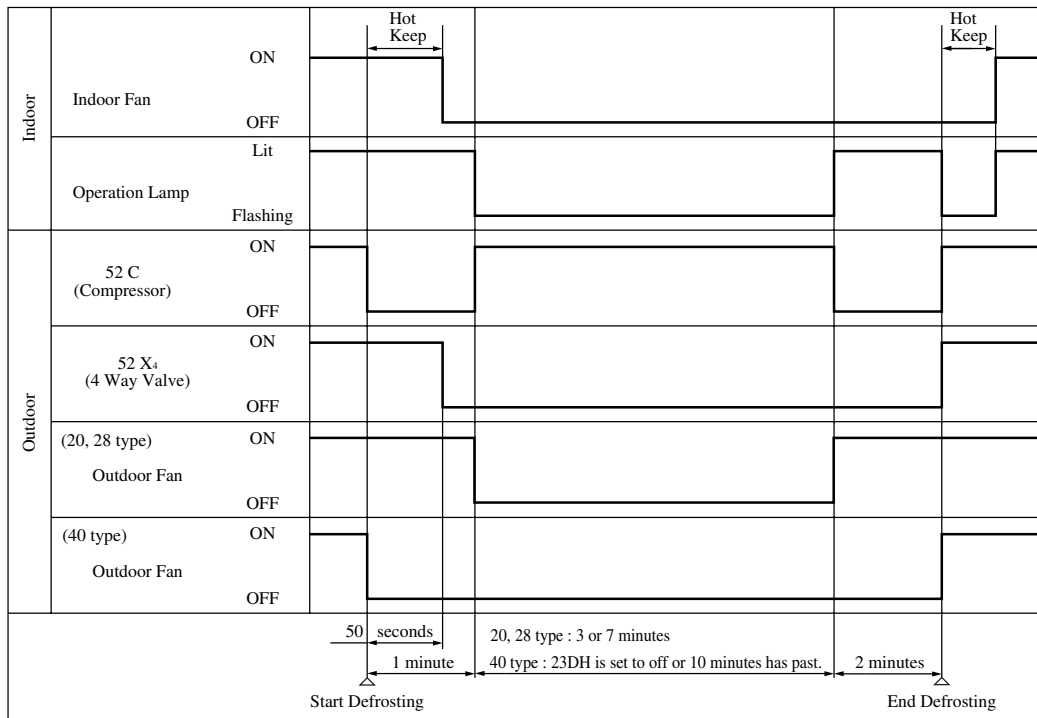

(8) Forced Defrosting

To perform defrosting during test operation, the following operation can be used only one time to perform defrosting operation.

(a) Temporarily turn off the power source and then perform the following operation using the remote controller within 20 seconds after the power is turned back on.

- Operation : **Run** Air flow : **Swing**
- Fan speed : **Low** Timer switch : **On timer (⊖)**
- Operation setting : **Heating** On time : **3H**
- Temperature setting : **19**

(b) The operation is performed on the remote controller. Forced defrost operation will be performed for one minute following the operation of the three minute delay timer. Following this, the entire system stops when 23DH is set to off or when 10 minutes has passed.

(9) Dew condensation prevention control for cooling operation

This prevents dew condensation, in the indoor unit, from occurring.

- (a) Operating condition:** when 52C is kept ON for 30 min. after the unit starts operation.
- (b) Operation content:** forces the indoor fan to change from Speed 1 to Speed 2.
- (c) Resetting condition:** When 52C is off, or when dew condensation prevention control has been operating continuously for 30 minutes.

(10) Frost prevention for indoor heat exchanger

During the Cooling or Dry operation in low room air temp. condition, evaporating temperature will decrease and consequently indoor heat exchanger sometimes gets clogged with frost (or ice).

In order to prevent this trouble, compressor is stopped by under mentioned condition by indoor heat exchanger sensor (Th₂) and timer (built into micro computer circuit) functions.

Also indoor fan is changed over to Lo speed.

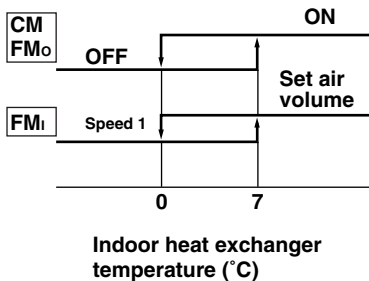

CM, FMO stoppage condition

- ① Temperature of heat exchanger is 0°C or lower.
- ② As least 10 minutes has passed since the compressor started.

CM, FMO re-starting condition

- ① Temperature of heat exchanger is 7°C or higher.
- ② As least 3 minutes has passed since the compressor stopped.

(11) High-Pressure Control

During heating, the compressor and fan for the indoor unit are controlled by heat exchanger temperature for the indoor unit (as detected by Th₂) as follows.

◆ SRK20HB, 28HB

- When the Indoor Heat Exchanger Temperature Is $\geq 54^{\circ}\text{C}$

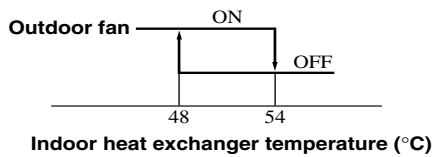

- When the Indoor Heat Exchanger Temperature Is $\geq 61^{\circ}\text{C}$

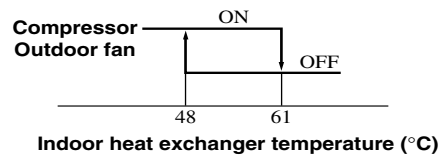

◆ SRK40HB

- Indoor fan control

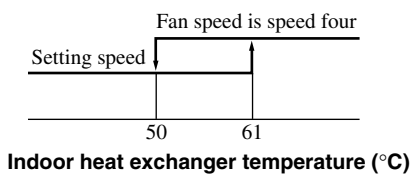

- Compressor control

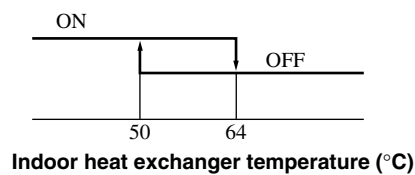

(12) Three-Minute Forced Operation

When the compressor begins operating the thermal operation is not effective for three minutes, so operation continues as is in the operation mode. (After three minutes has passed the thermal operation is effective.)

However, stopping the compressor via a stop signal or protection control has priority.

(13) Heating operation overload protection (SRK40HB only)

During heating operation in overload condition (room outside air temperature is considerably high), in order to protect the unit, the outdoor fan is controlled by the pressure switch (63H) and the compressor and outdoor fan are controlled by the heat exchanger sensor (Th2)

(a) Outdoor fan control

High pressures are prevented and extreme heat absorption controlled by turning the outdoor fan ON and OFF with the pressure switch.

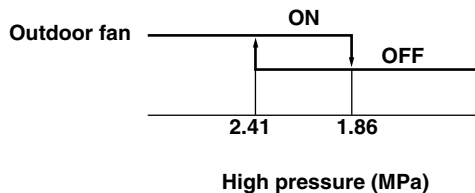

(b) Compressor and outdoor fan control

When high pressure occurs even with the outdoor fan off, stop the compressor and outdoor fan with the indoor heat exchange sensor to protect the unit.

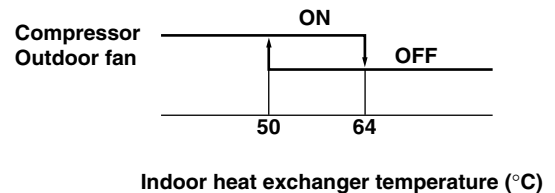

(14) Self diagnosis function





When something abnormal happens on the outdoor unit, indoor unit fan motor and each sensor (heat exchanger, room temperature), it will be indicated by flashing lamps.

- (a) **Abnormality of outdoor unit:** TIMER lamp will flashing when 5 minutes after it has been operated with the compressor ON(52C ON) the temperature on heat exchanger sensor will not go below 25°C for more than 20 minutes for cooling and will not go over 30°C for more than 20 minutes for heating.
(The compressor will stop when cooling more than 20 minutes after flashing of the lamp, or heating above 25°C and below 30°C.)
- (b) **Abnormality of indoor fan motor:** The indoor fan motor revolves at a rate under 300 rpm for 30 seconds or longer, the RUN lamp will flash.
- (c) **Abnormality of heat exchanger sensor:** RUN lamp will flashing when the input temperature of the heat exchanger sensor measures less than -20°C for more than 3 seconds with the air-conditioner "OFF". (will not flashing during operation)
- (d) **Abnormality room temperature sensor:** RUN lamp will flashing when the input temperature of the room temperature sensor measures less than -20°C for more than 3 seconds with the air-conditioner "OFF". (will not flashing during operation)

Note (1) If the above abnormalities happen concurrently, the lamp will flashing in the order of item number (a) through (d) above.

5 APPLICATION DATA



SAFETY PRECAUTIONS

- Please read these “Safety Precautions” first then accurately execute the installation work.
- Though the precautionary points indicated herein are divided under two headings,  **WARNING** and  **CAUTION**, those points which are related to the strong possibility of an installation done in error resulting in death or serious injury are listed in the  **WARNING** section. However, there is also a possibility of serious consequences in relationship to the points listed in the  **CAUTION** section as well. In either case, important safety related information is indicated, so by all means, properly observe all that is mentioned.
- After completing the installation, along with confirming that no abnormalities were seen from the operation tests, please explain operating methods as well as maintenance methods to the user (customer) of this equipment, based on the owner’s manual. Moreover, ask the customer to keep this sheet together with the owner’s manual.

WARNING

- This system should be applied to places as households, residences and the like. Application to inferior environment such as engineering shop could cause equipment malfunction.
- Please entrust installation to either the company which sold you the equipment or to a professional contractor. Defects from improper installations can be the cause of water leakage, electric shocks and fires.
- Execute the installation accurately, based on following the installation manual. Again, improper installations can result in water leakage, electric shocks and fires.
- For installation, confirm that the installation site can sufficiently support heavy weight. When strength is insufficient, injury can result from a falling of the unit.
- For electrical work, please see that a licensed electrician executes the work while following the safety standards related to electrical equipment, and local regulations as well as the installation instructions, and that only exclusive use circuits are used.
Insufficient power source circuit capacity and defective installment execution can be the cause of electric shocks and fires.
- Accurately connect wiring using the proper cable, and insure that the external force of the cable is not conducted to the terminal connection part, through properly securing it improper connection or securing can result in heat generation or fire.
- Take care that wiring does not rise upward, and accurately install the lid/service panel. It’s improper installation can also result in heat generation or fire.
- When setting up or moving the location of the air conditioner, do not mix air etc. or anything other than the designated refrigerant (R22) within the refrigeration cycle.
Rupture and injury caused by abnormal high pressure can result from such mixing.
- Always use accessory parts and authorized parts for installation construction. Using parts not authorized by this company can result in water leakage, electric shock, fire and refrigerant leakage.
- Ventilate the work area when refrigerant leaks during the operation. 
Coming in contact with fire, refrigerant could generate toxic gas.
- Confirm after the foundation construction work that refrigerant does not leak.
If coming in contact with fire of a fan heater, a stove or movable cooking stove, etc., refrigerant leaking in the room could generate toxic gas.

CAUTION

- Execute proper grounding. Do not connect the ground wire to a gas pipe, water pipe, lightning rod or a telephone ground wire. 
Improper placement of ground wires can result in electric shock.
- The installation of an earth leakage breaker is necessary depending on the established location of the unit.
Not installing an earth leakage breaker may result in electric shock.
- Do not install the unit where there is a concern about leakage of combustible gas. 
The rare event of leaked gas collecting around the unit could result in an outbreak of fire.
- For the drain pipe, follow the installation manual to insure that it allows proper drainage and thermally insulate it to prevent condensation. Inadequate plumbing can result in water leakage and water damage to interior items.

5.1 Selection of location for installation

(1) Indoor unit

- Where there is no obstructions to the air flow and where the cooled air can be evenly distributed.
- A solid place where the unit or the wall will not vibrate.
- A place where there will be enough space for servicing. (Where space mentioned below can be secured)
- Where wiring and the piping work will be easy to conduct.
- The place where receiving part is not exposed to the direct rays of the sun or the strong rays of the street lighting.

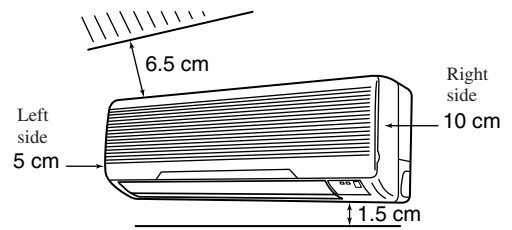

(2) Outdoor unit

- A place where good air circulation can be obtained.
- A place where the exhausted air will not be sucked in for the second time.
- A place where the unit will not be affected by other heat sources. (When there are several units installed or another heat source)
- Do not install the unit near the seaside, or where there is possibility of chlorine gas generation.
- A place where discharged hot and cold air or unit's operating sound will not be nuisance to the neighborhood.
- A place where servicing space can be secured.
- A place where vibration will not be enlarge.
- In heating operation, snow deposit on the heat-exchanger of outdoor unit must be prevented for keeping the normal performance capacity.
 - Snow-hood on outdoor unit as in drawing, will reduce the frequency of defrost operation.
When installing the snow hood, take care so that the air outlet of the snow hood will not face directly into the most windy direction.
 - Design the base higher than possible snow deposit.

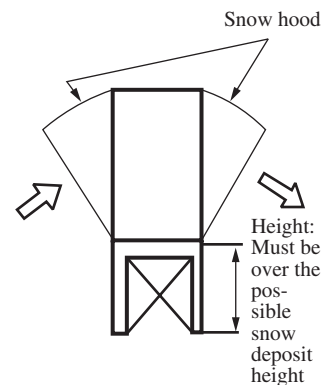
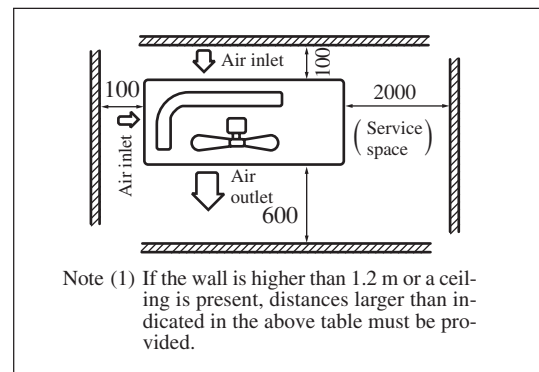

(3) Limitations for one way piping length and vertical height difference.

| | | Model | All models |
|----------------------------------|------------------------|-------|------------|
| Item | | | |
| One way piping length (ℓ) | | | 15 |
| Vertical height difference (h) | Outdoor unit is lower | | 5 m |
| | Outdoor unit is higher | | 5 m |

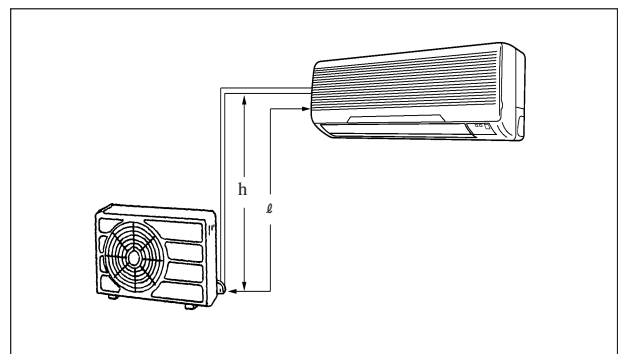

5.2 Installation of indoor unit

(1) Installation of installation board

(a) Fixing of installation board

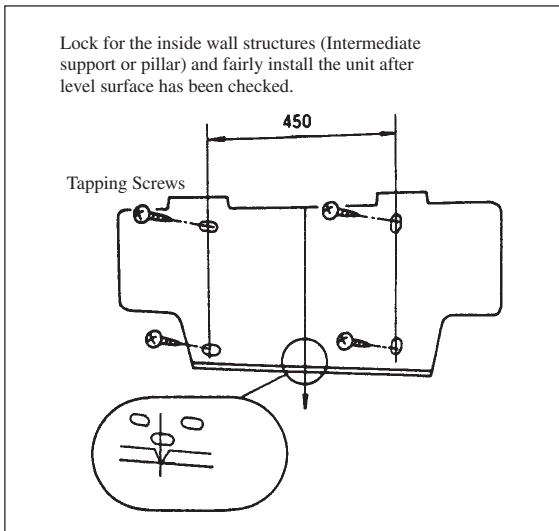

Adjustment of the installation board in the horizontal direction is to be conducted with four screws in a temporary tightened state.

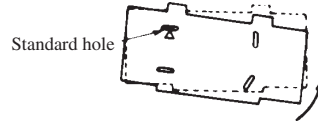

Adjust so that board will be level by turning the board with the standard hole as the center.

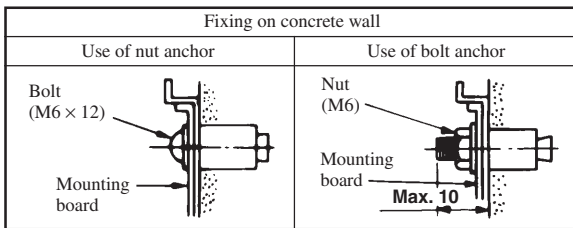

(2) Drilling the and installation of sleeve

(a) Drill a hole with $\varnothing 65$ whole core drill

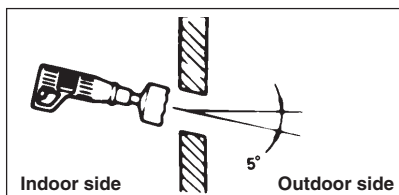

Note (1) Drill a hall with incline of 5 degree from indoor side to outdoor side.

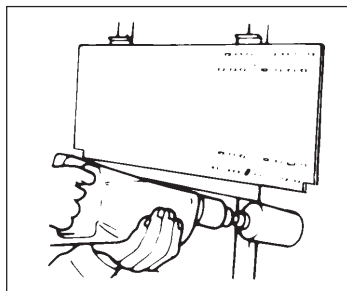

(b) Adjusting sleeve length (Option parts)

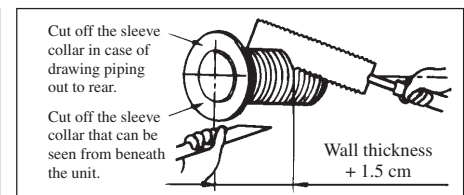

(c) Install the sleeve

(Inserting sleeve)

(*Sleeve + *Inclined + *Sealing plate)

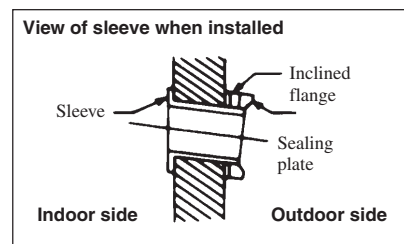
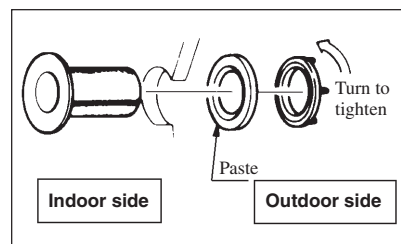
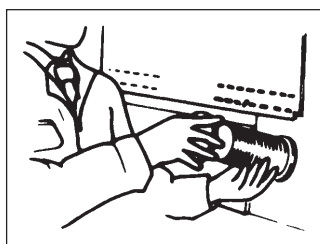

(3) Preparation of indoor unit

(a) Mounting of connecting wires

- (i) Remove lid.
- (ii) Remove cover, terminal block cover.
- (iii) Connect the connection wire securely to the terminal block.

Use cables for interconnection wiring to avoid loosening of the wires. CENELEC code for cables Required field cables.

H05 RNR3G1.5 (Example)

H Harmonized cable type

05 300/500 volts

R Natural-and/or synth, rubber wire insulation

N Polychloroprene rubber conductors insulation

R Stranded core

3or5 Number of conductors

G One conductor of the cable is the earth conductor (yellow/green)

1.5 Section of copper wire (mm²)

- ① Affix the connection wire securely to the terminal block. If the wire is not affixed completely, contact will be poor, and it is dangerous as the terminal block may heat up and catch fire.
 - ② Take care not to confuse the terminal numbers for indoor and outdoor connections.
 - ③ Affix the connection wire using the wiring clamp.
- (iv) Attach the terminal block cover.
 - (v) Attach the lid.

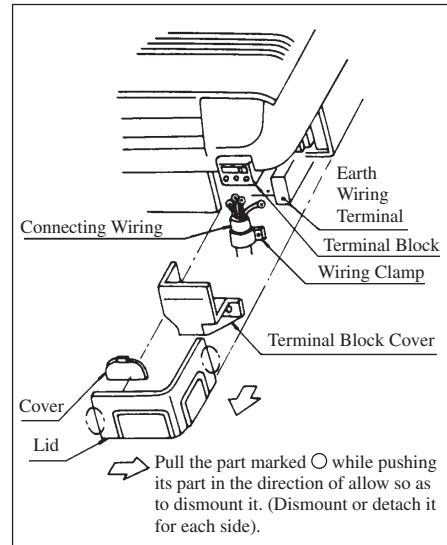

(b) **Protective taping** (Protect the cable with tape at the section where the cable passes through the hole opened on the wall.)

(c) **Forming of pipe** (Holding down the pipe at the root, change the pipe direction, extend it and adjust according to the circumstance.)

[When the pipe is extended to left and taken out from the rear center]

- When extending the pipe to the left side, utilize the “Folded support” provided at the rear of the indoor unit base. (Adjust the end of support to be placed on the mounting board. Refrain from contacting it directly with the wall because it could damage the wall.)

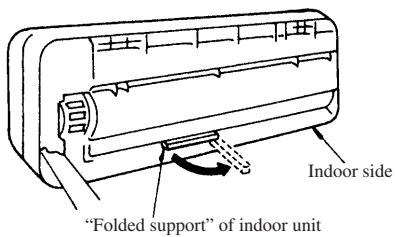

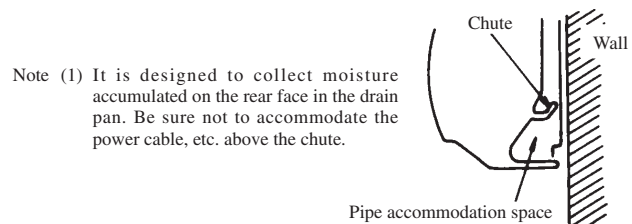
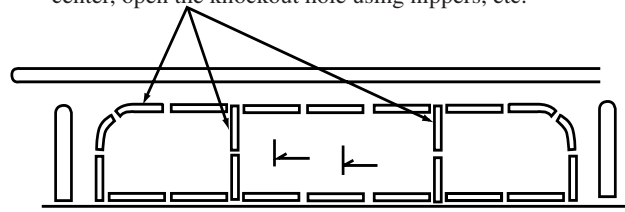

- When arranging the pipe through a hole opened at the center, open the knockout hole using nippers, etc.

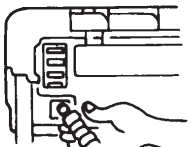
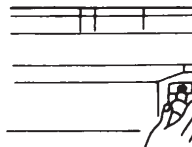
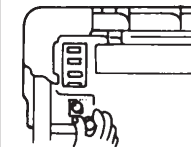

Note (1) It is designed to collect moisture accumulated on the rear face in the drain pan. Be sure not to accommodate the power cable, etc. above the chute.

< Drain pipe relocation procedure >

| 1. Remove the drain pipe. | 2. Remove the drain cap. | 3. Insert the drain cap. | 4. Connect the drain pipe. |
|---|---|---|---|
|  |  |  |  |

- Loosen the spring clamp to remove.

- Remove by hand or use cutting pliers, etc.

- Securely insert the drain cap removed in the step 2.
Note: If it is inserted insufficiently, water leakage could result.

- Loosen the spring clamp and securely insert the drain pipe.
Note: If it is inserted insufficiently, water leakage could result.

(4) Installation of indoor unit

(a) Install the indoor unit on the mounting plate.

Hook the upper part of the indoor unit on the stoppers disposed at the upper part of the mounting plate and lightly push the lower part of the indoor unit so that the unit is fixed in position.

- When removing the indoor unit

- ① Disconnect the lid at right and left.
- ② Pull down the stoppers (right and left) provided at the bottom of the indoor unit base. (See the detail view shown at right.)
(The stoppers are separated from the mounting plate.)

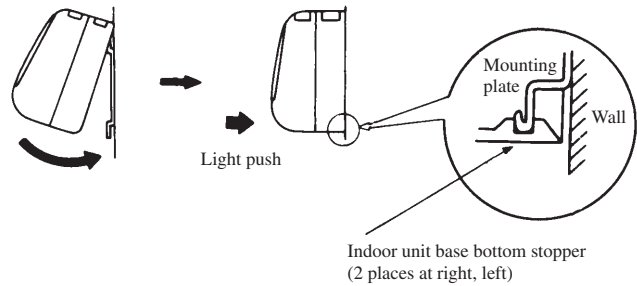

(b) Be sure not to leave any trap on the drain pipe.

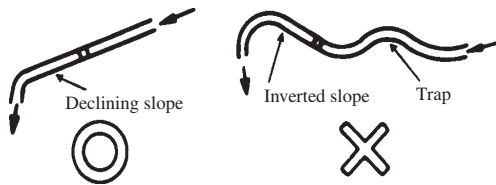

5.3 Installation of outdoor unit

(1) Installation of outdoor unit

- (a) Make sure that sufficient space for installation and service is secured.

- (b) Fix the leg sections of the unit on a firm base which will not play.

Attach cushion pads, etc. between the unit and the mounting fixtures not to transmit vibration to the building.

- (c) Attach a drain elbow, etc. under the drain port of the bottom plate to guide drain water.

(Drain elbow should not be used where days when temperature drops below 0°C continue for several days. Draining may be disturbed by frozen water.)

- (d) When installing the unit at a higher place or where it could be toppled with strong winds, secure the unit firmly with foundation bolts, wire, etc.

(2) Connection of indoor and outdoor connecting wiring

- (a) Connect the wiring according to the number of the indoor terminal block. (Mis-wiring may cause the burning damage, and make sure to connect correctly.)

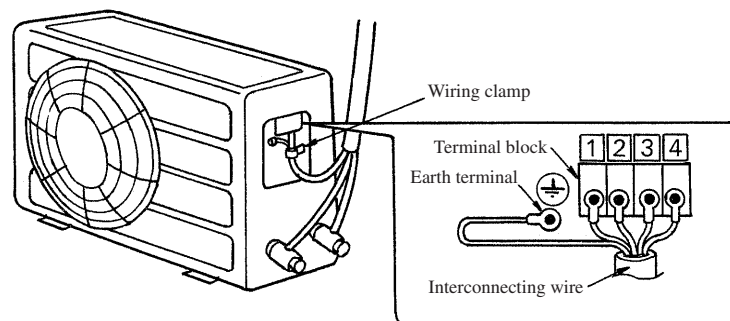

5.4 Refrigerant piping

(1) Preparation

Keep the openings of the pipes covered with tapes etc. to prevent dust, sand, etc. from entering them.

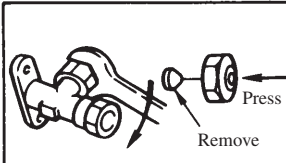
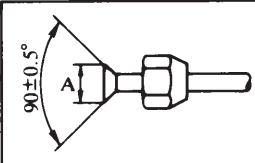
| Indoor unit side | Outdoor unit side | | Dimension A Liquid side ($\phi 6.35$): 9-9.5 dia Gas side ($\phi 9.52$): 13.2-13 dia ($\phi 12.7$): 16.2-17 dia |
|--|--|---|--|
|  |  |  | |
| <ul style="list-style-type: none"> Remove the flared nuts. (on both liquid and gas sides) | <ul style="list-style-type: none"> Remove the flared nuts. (on both liquid and gas sides) | <ul style="list-style-type: none"> Install the removed flared nuts to the pipes to be connected, then flare the pipes. | |

(2) Connection of refrigerant piping

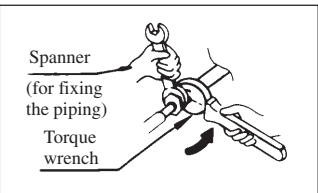
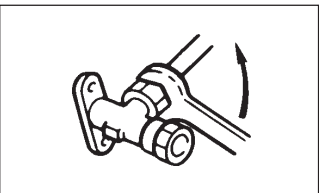
| Indoor unit side | Outdoor unit side |
|--|--|
| <ul style="list-style-type: none"> Connect firmly gas and liquid side pipings by Torque wrench.  | <ul style="list-style-type: none"> Connect firmly gas and liquid side pipings by Torque wrench.  |
| <ul style="list-style-type: none"> Specified torquing value: Liquid side ($\phi 6.35$): 15.7~19.6N·m(1.6~2.0kgf·m) Gas side ($\phi 9.52$) : 29.4~39.2N·m(3~4kgf·m) ($\phi 12.7$) : 39.2~49N·m(4~5kgf·m) | <ul style="list-style-type: none"> Specified torquing value: Liquid side ($\phi 6.35$): 15.7~19.6N·m(1.6~2.0kgf·m) Gas side ($\phi 9.52$) : 29.4~39.2N·m(3~4kgf·m) ($\phi 12.7$) : 39.2~49N·m(4~5kgf·m) |
| <ul style="list-style-type: none"> Always use a Torque wrench and back up spanner to tighten the flare nut. | <ul style="list-style-type: none"> Use one more spanner to fix the valve. |

(3) Air purge

- Tighten all flare nuts in the pipings both indoor and outside wall so as not to cause leak.
- Connect operating valve, charge hose, manifold valve and vacuum pump as is illustrated below.
- Open manifold valve handle Lo to its full width, and perform vacuum or evacuation. Continue the vacuum or evacuation operation for 15 minutes or more and check to see that the vacuum gauge reads -101 kPa (-76 cmHg).
- After completing vacuum operation, fully open service valve (Both gas and liquid sides) with hexagon headed wrench.
- Check for possible leakage of gas in the connection parts of both indoor and outdoor.

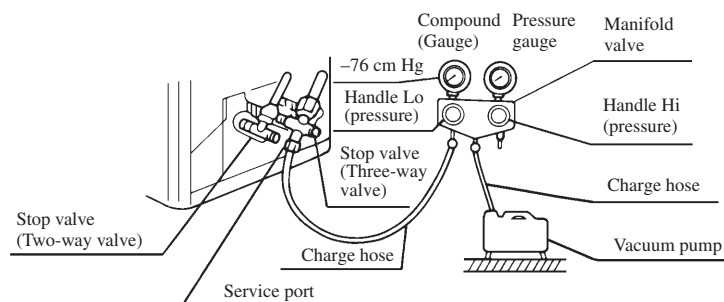

Additional refrigerant charge

When refrigerant piping exceeds 7.5 m conduct additional refrigerant charging after refrigerant sweeping.

Max. 10m Additional charge amount per meter = 20 g/m

10m over 15m Additional charge amount per meter = 30 g/m

[Example]

How much amount of additional charge for 10m piping?

$(10 - 7.5) \text{ m} \times 20 \text{ g/m} = 50 \text{ g}$ 50gr for additional charge

How much amount of additional charge for 15m piping?

$(10 - 7.5) \text{ m} \times 20 \text{ g/m} + (15 - 10) \text{ m} \times 30 \text{ g/m} = 200 \text{ g}$ 200gr for additional charge

(4) Insulation of the connection portion

- (a) Cover the coupling with insulator and then cover it with tape.

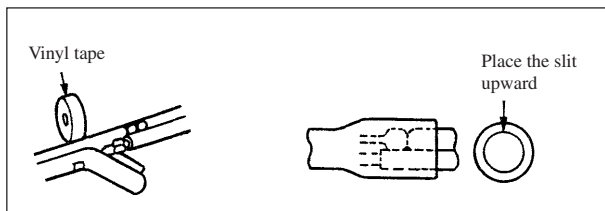

- (b) Finishing and fixing

- (i) Tie up the piping with wrapping tape, and shape it so that it conforms to which the pipe is attached.
(ii) Fix them with clamps as right figure.

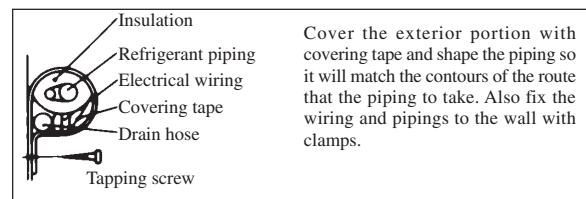

5.5 Test run

- (1) Check carefully for gas leakage before performing the trial operation.
- (2) Make sure that drain flows properly. (Right figure)
- (3) If power source voltage is low and difficult to start air conditioner, ask your local electric power company to raise voltage. (Of it is not correct there may occur breaker trip or bournung.)
- (4) Make sure that power source is wired as exclusive use for air conditioner and there is no looseness or play between plug socket and plug. (Plug socket is to be purchased locally.)
(When there is something wrong with the electric outlet and if the insertion of the electric plug is insufficient, there may occur a burn out.)
- (5) 3 minutes delay circuit operation under the following conditions:
 - (a) When the air conditioner is stopped by pressing ON/ OFF switch.
 - (b) When thermostat actuates.
 - (c) When operation is changed from cooling or dry to fan.
- (6) Explain well the correct usage of the air conditioner carefully to the customer following the instruction manual.

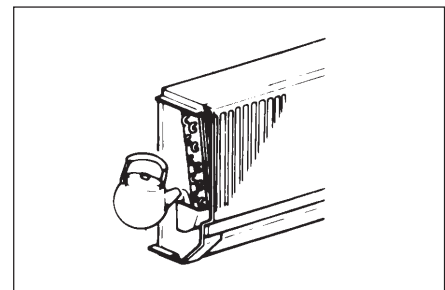

[Example]

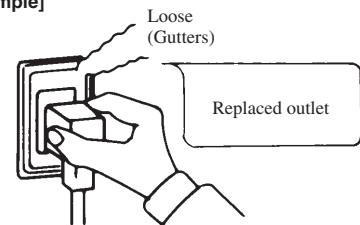

(7) Standard operation data

(220/240V)

| Model | | SRK20HB | SRK28HB | SRK40HB |
|---|---------|-----------|-----------|-----------|
| High pressure (MPa) | Cooling | – | – | – |
| | Heating | 1.47~1.67 | 1.67~1.86 | 1.76~1.96 |
| Low pressure (MPa) | Cooling | 0.44~0.54 | 0.39~0.49 | 0.39~0.49 |
| | Heating | – | – | – |
| Temp. difference between suction air and discharge air (°C) | Cooling | 14~16 | 11~15 | 12~16 |
| | Heating | 16~18 | 18~22 | 18~22 |
| Running current (A) | Cooling | 3.4/3.6 | 4.5/4.6 | 6.4/6.4 |
| | Heating | 3.0/3.4 | 4.0/4.1 | 6.5/6.5 |

Note (1) The data are measured at following conditions
Ambient air temperature
 Indoor side: Cooling ... 27°C DB, 19°C WB, Heating ... 20°C DB
 Outdoor side: Cooling ... 35°C DB, 24°C WB, Heating ... 7°C DB, 6°C WB

5.6 Precautions for wireless remote controller installation and operation

(1) Wireless remote controller covers the following distances:

(a) When operating facing the air conditioner:

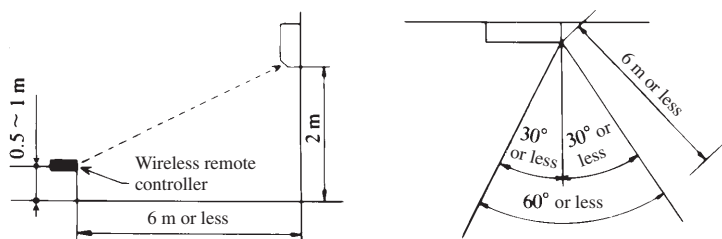

- Notes (1) The remote controller is correctly facing the sensing element of the air conditioner when being manipulated.
- (2) The typical coverage is indicated (in the left illustration). It may be more or less depending on the installation.
- (3) The coverage may be less or even nil, if the sensing element is exposed to strong light, such as direct sunlight, illumination, etc., or dust is deposited on it or it is used behind a curtain, etc.

(b) When manipulating the remote controller mounted on a wall:

Make sure that it works normally (i.e., transmission/reception signal is audible) before mounting.

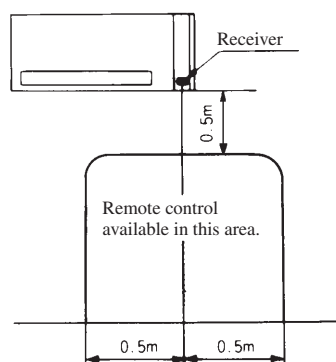

6 MAINTENANCE DATA

6.1 Trouble shooting

(1) Trouble shooting to be performed prior to exchanging PCB, (Printed circuit board) [Common to all models]

All the models described in this chapter are controlled by a microcomputer. When providing maintenance service to customers it is necessary to understand the function controlled by a micro computer thoroughly, so as not to mistakenly identify correct operations as mis-operations. **It is also necessary to perform the following simple checks before conducting detailed checks or exchanging printed circuit board.**

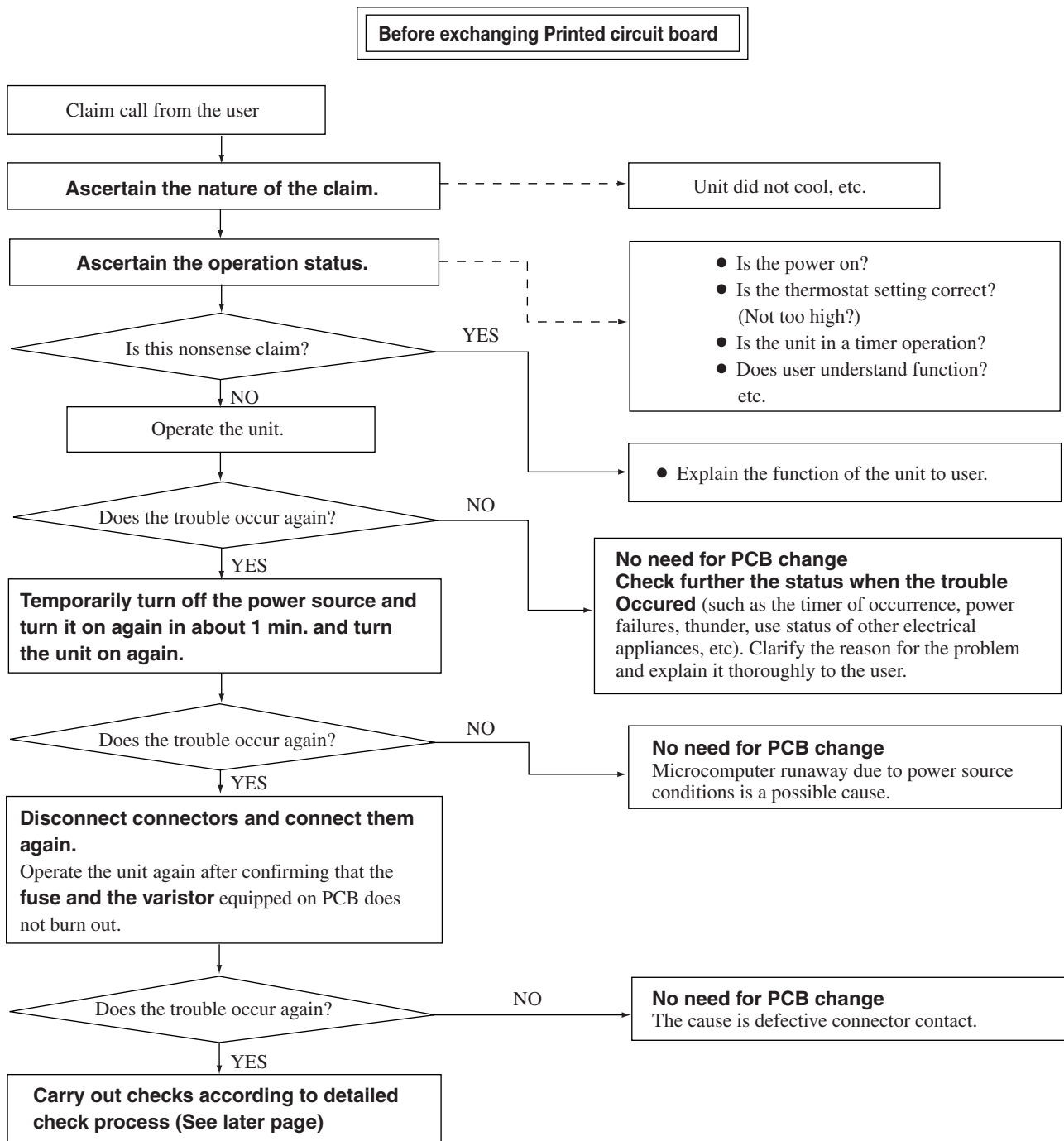

(2) Indication of Self Diagnosis (Indoor unit)

| | Connect of Defect | Place of defect |
|------------------------------------|--|--|
| TIMER lamp is lights continuously. | RUN lamp is flashing. (1 Times/8 sec.) | Abnormality of heat exchanger sensor. ● Disconnection of heat exchanger sensor. |
| | RUN lamp is flashing. (2 Times/8 sec.) | Abnormality of room temperature sensor. ● Disconnection of room temperature sensor. |
| | RUN lamp is flashing. (6 Times/8 sec.) | Abnormality of indoor fan motor. ● Fan motor is defective. ● Printed circuit board is defective. |
| RUN lamp is lights continuously. | TIMER lamp is flashing. (5 Times/8 sec.) | Abnormality of outdoor unit. ● Compressor is defective. ● Capacitor is defective. ● Gas is short. |

(3) Troubleshooting

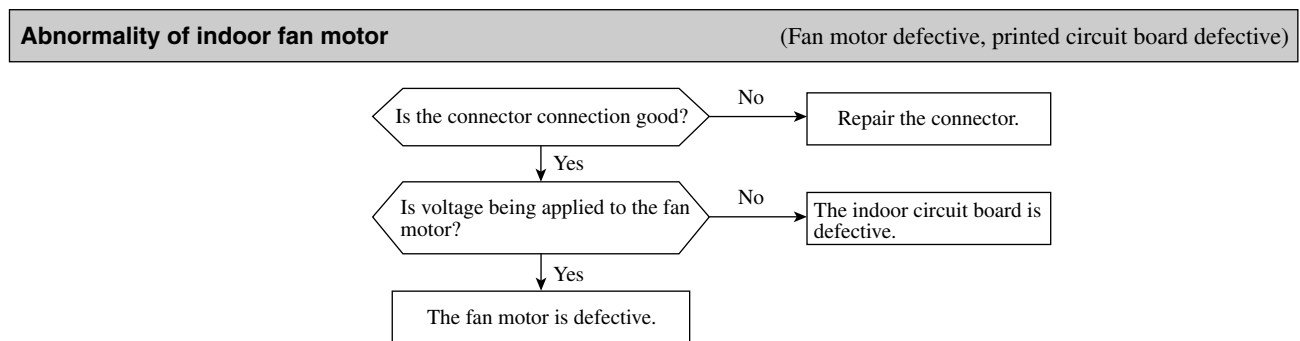
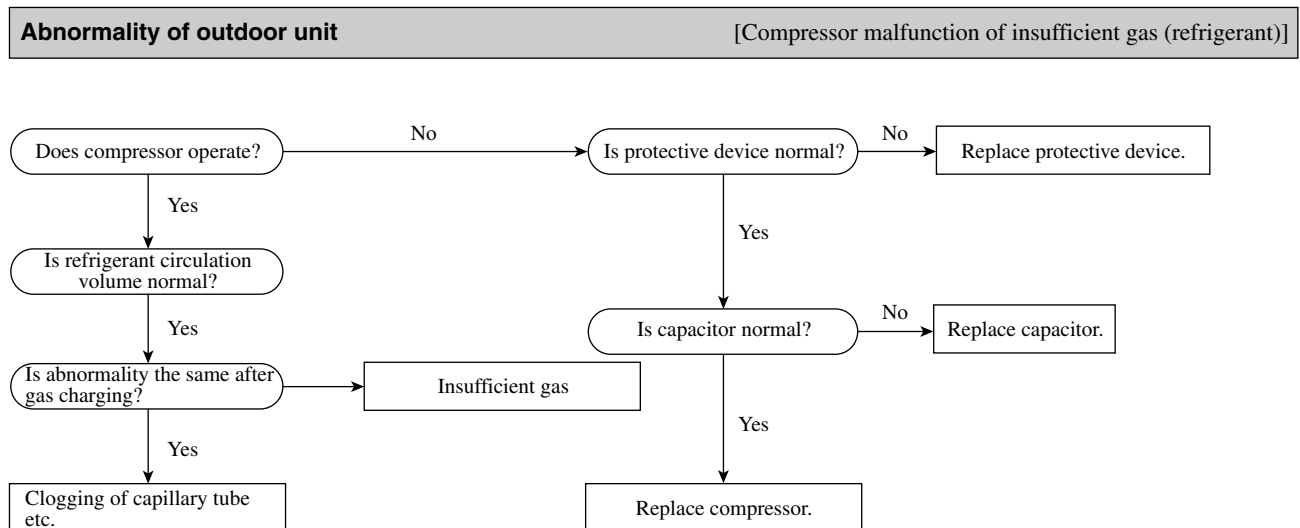

Abnormality of sensor

[Disconnection of sensor and defective connection of connector]

Chart for thermistor temperature resistance characteristics

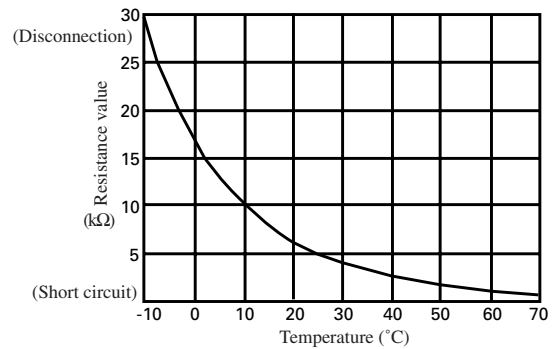
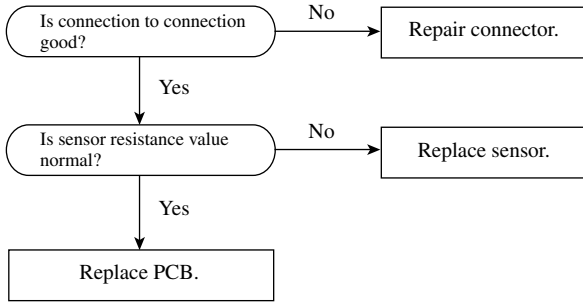

(4) Trouble Diagnostic procedures

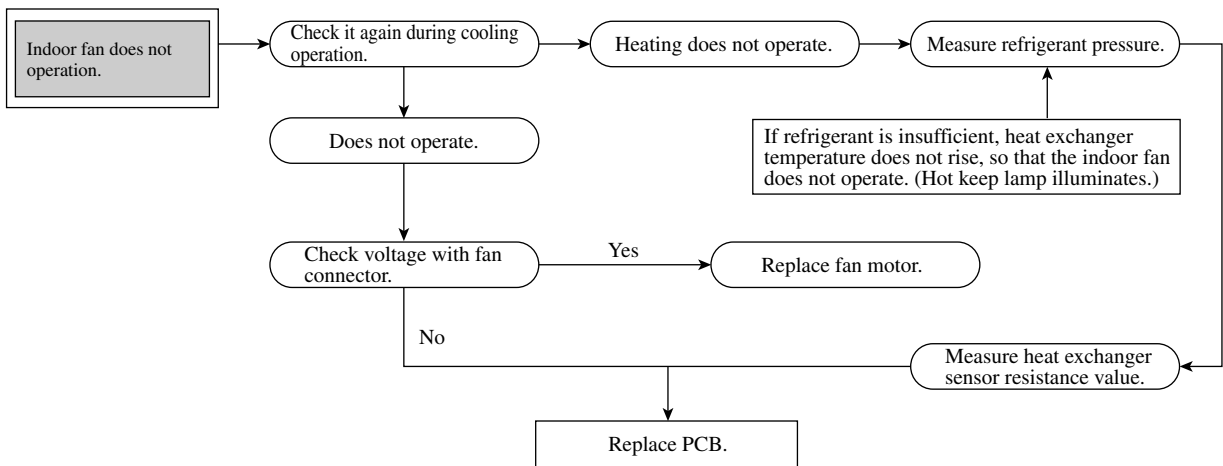
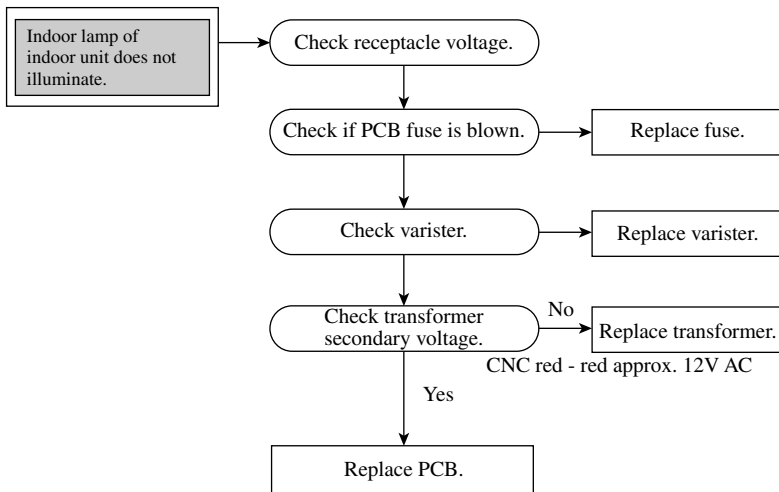
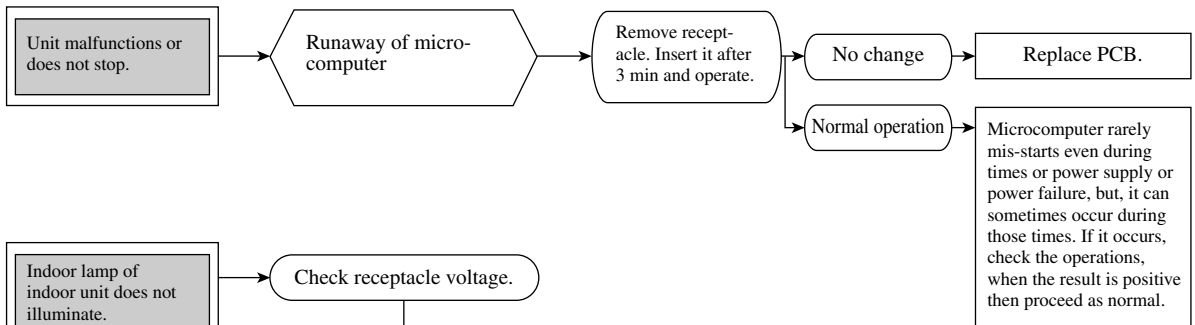

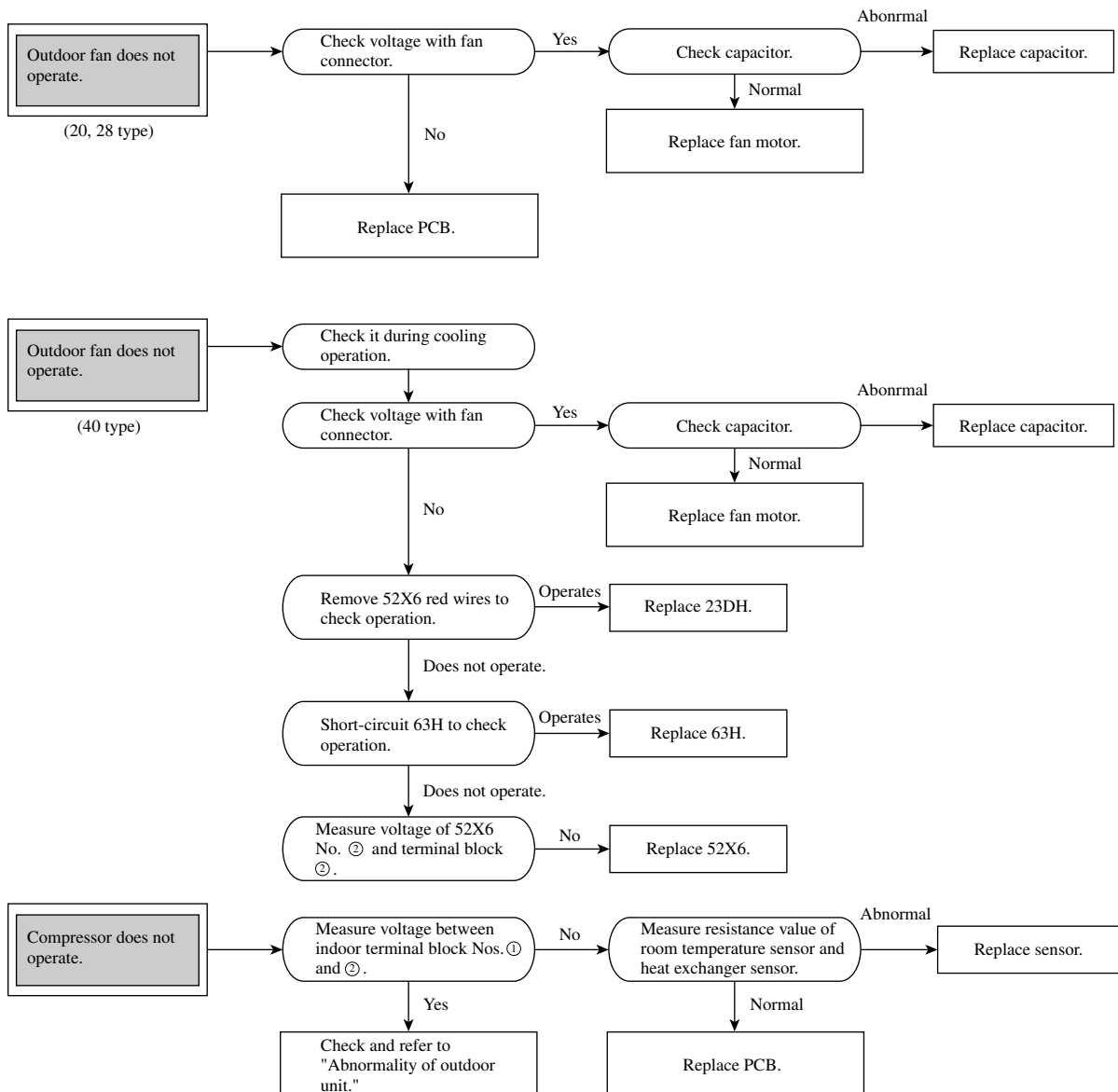

(5) Trouble shooting chart for the room temperature sensor (Th₁), heat exchanger sensor (Th₂) and defrost thermostat (23DH)

| Unit | Sensor | Operation | Function | |
|--------------|---|-----------|---|--|
| | | | Short circuit | Broken connection |
| Indoor unit | Room temperature sensor(1) (Th ₁) except for "continuous" thermal setting | Cooling | Continuous Cooling operation <ul style="list-style-type: none"> Cannot be turned ON/OFF by thermostat When FM_i is on, "AUTO" is continuously Hi | Cooling will not operate <ul style="list-style-type: none"> FM_i: continuous operation CM, FMO: stopped |
| | | Heating | Heating will not operate (CM, FMO, FM _i all stopped) | Continuous heating operation <ul style="list-style-type: none"> Cannot be turned ON/OFF by thermostat When FM_i is on, "AUTO" is continuously Hi |
| | Heat exchanger sensor (Th ₂) | Cooling | Cooling will not operate | Cooling will operate <ul style="list-style-type: none"> Heat exchanger frost preventer begins to operate Cools alternately for 10 minutes, stopping for 3 minutes |
| | | Heating | Heating will not operate <ul style="list-style-type: none"> Heating overload protect begins to operate When FM_i is on, "AUTO" is continuously Hi CM, FMO are stopped | Heating will not operate normally <ul style="list-style-type: none"> CM, FMO are ON FM_i is OFF Hot keep lamp illuminated |
| Outdoor unit | Defrost thermostat (23DH) (40 type only) | Cooling | Cooling will not operate (blown breaker) <ul style="list-style-type: none"> CM, FM_i are ON FMO is OFF | No effect |
| | | Heating | Heating will operate normally (The defrosting will operate normally, but 23 DH reset is not possible. Defrosts for 10 minutes) | Heating will operate <ul style="list-style-type: none"> Unable to defrost⁽²⁾ Will not operate for very long when outside air temperature is low |

Notes

- When the room temperature sensor (Th₁) will not operate normally, Cooling or heating operation may be run continuously by putting the thermostat setting on "CONTINUOUS"
- When switching to the defrost cycle, 23DH opens (broken connection), the mechanism resets to heating, and defrosting will not operate.

(6) How to make sure of remote controller

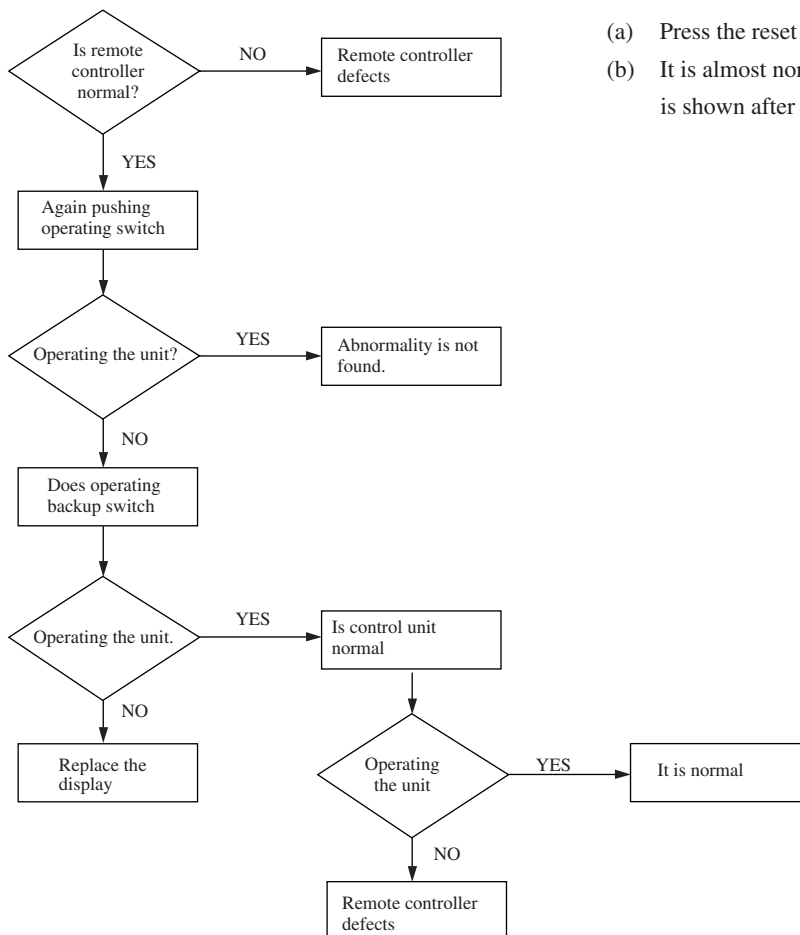

- Press the reset switch of the remote controller.
- It is almost normal if entire display of remote controller is shown after  indication.

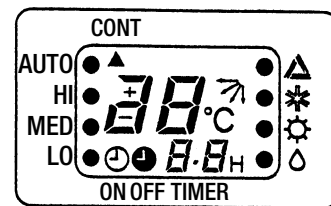

6.2 Servicing

(1) Evacuation

The evacuation is an procedure to purge impurities.....noncondensable gas, air, moisture from the refrigerant equipment by using a vacuum pump. Since the refrigerant R22 is very insoluble in water, even a small amount of moisture left in the refrigerant equipment will freeze, causing what is called water clogging.

● Evacuation procedure

- Check to ensure that there is no internal pressure in the unit. If there is an internal pressure, it should be relieved through the check joint.
- Connect the service hoses of the gauge manifold to the check joint of the gas & liquid piping.
- Connect a vacuum pump to the charge hose (A). Repeat evacuation in the following sequence.

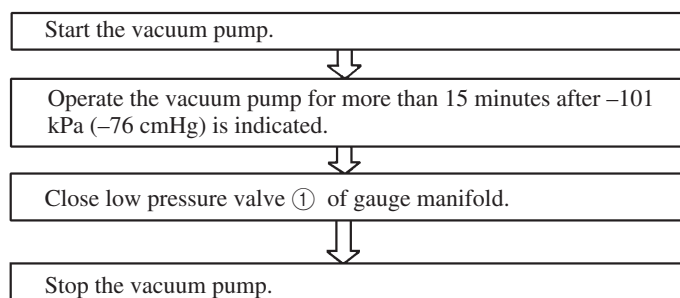

- Notes
- Do not use the refrigerant pressure to expel air.
 - Do not use the compressor for evacuation.
 - Do not operate the compressor in the vacuum condition.

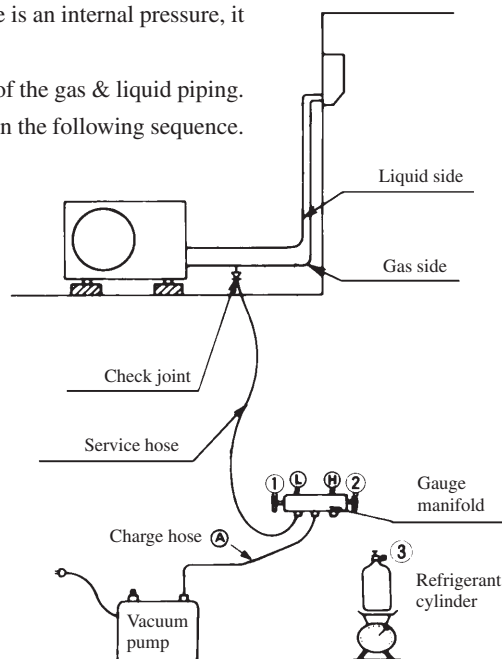

(2) Refrigerant charge

- Discharge refrigerant entirely from the unit and evacuate the unit.
Note: Addition of refrigerant without evacuation is unreasonable, because it will result in low charge or overcharge.
- Keep the gauge manifold and connect a refrigerant cylinder to the unit.
- Record the weight of the refrigerant cylinder on the balance. This is necessary for making sure of the charged refrigerant amount.
- Purge air from the charge hose (A)
Firstly loose the connecting portion of the charge hose (A) at the gauge manifold side and open the valve (3) for a few seconds, and then immediately retighten it after observing that gas is blow out from the loosened portion.
- Open the valve (1) and (3) after discharging air from the charge hose (A), then the gas refrigerant begins flowing from the cylinder into the unit. Be sure to erect the refrigerant cylinder upright to let gas refrigerant flow into the unit.
- When refrigerant has been charged into the system to some extent, **refrigerant flow becomes stagnant, when that happens, start the compressor in cooling cycle until the unit is filled with gas to the specified weight.**
- Making sure of the refrigerant amount, close the valve (3)
- Disconnect the charge hose from the unit. Cover the valve ports of the refrigerant piping with caps and tighten them securely.
- Check for gas leakage applying a gas leak detector along the piping line.
- Start the air conditioner and make sure of its operating condition.....high side and low side pressures and temperature difference between suction air and outlet air.

6.3 Power supply remote operation

When the remote part on indoor unit PCB is modified, the air-conditioner is turned ON-OFF by power supply ON-OFF operation without using remote control switch.

After the power supply remote operation, the operation contents can be modified by the remote controller.

(1) Operation contents

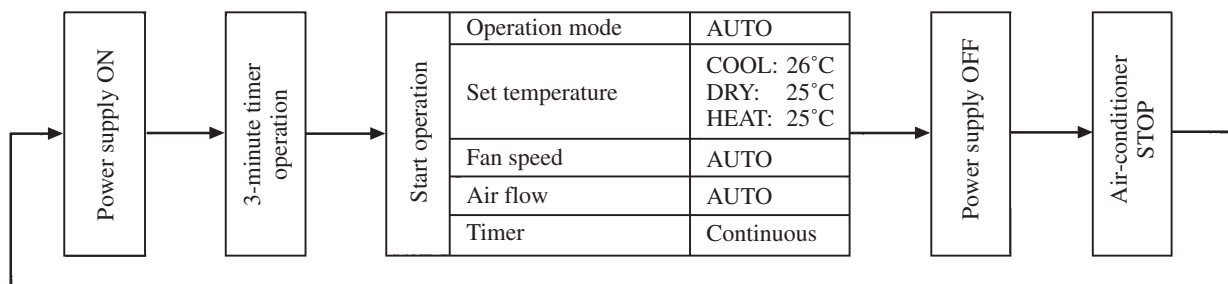

(2) Modification method

Solder the high-speed switching diode (manufacturer: Matsushita, Manufacture type No.: MA165) to “Remote” part on the PCB in the direction as shown in the diagram below.

This diagram shows SRK28HB and although the other units have different layout on the PCB, their concepts are same.

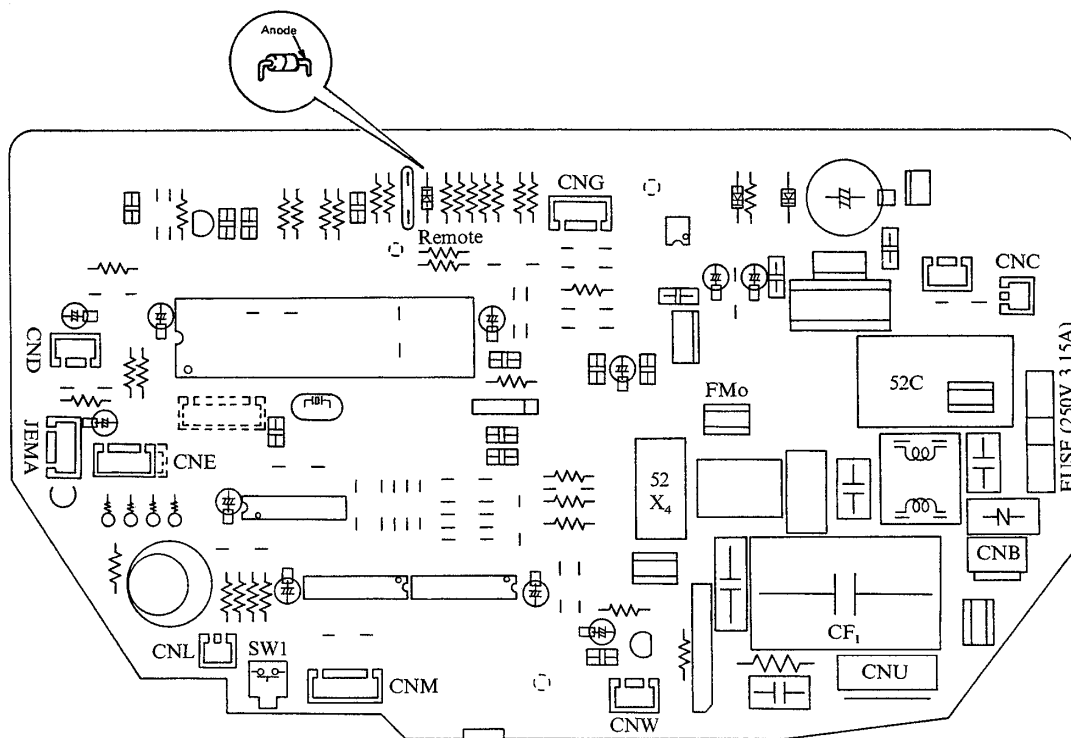

WALL MOUNTED TYPE ROOM AIR-CONDITIONER



Air-Conditioning & Refrigeration Systems Headquarters
16-5, 2-chome, Kounan, Minato-ku, Tokyo, 108-8215, Japan
Fax : (03) 6716-5926